



# ContiPressureCheck™

The system for permanent tire monitoring

 Translation of the original Installation  
Manual

## ContiPressureCheck™

<b>1</b>	<b>General</b> .....	<b>6</b>
1.1	Information on this installation manual.....	6
1.2	Liability disclaimer.....	7
1.3	Explanation of symbols.....	7
1.4	Abbreviations.....	8
1.5	Warnings.....	9
1.6	Copyright.....	10
1.7	Warranty terms.....	10
1.8	Manufacturer's address.....	10
1.9	After-sales service.....	10
<b>2</b>	<b>Safety</b> .....	<b>11</b>
2.1	General.....	11
2.2	Prohibition of modifications.....	11
2.3	Intended use.....	12
2.4	Fundamental safety instructions.....	13
2.5	Particular hazards.....	14
2.6	Staff requirements.....	16
2.7	Personal protective equipment.....	17
<b>3</b>	<b>Technical data</b> .....	<b>18</b>
3.1	Tire sensor.....	18
3.2	Central control unit.....	20
3.3	Additional receiver (optional).....	20
3.4	Display.....	21
3.5	Hand-Held Tool.....	22
3.6	Pressure control indicator.....	22

# Table of Contents

---

<b>4</b>	<b>Design and Function.....</b>	<b>23</b>
4.1	Description of functions.....	23
4.2	Overview.....	23
4.3	Configurations .....	24
4.4	Tire sensor .....	25
4.5	Central Control Unit (CCU) .....	26
4.6	Additional receiver (optional).....	27
4.7	Display .....	28
4.8	Holder .....	29
4.9	Commercial vehicle cabling .....	30
4.10	Pressure control indicator trailer/semi-trailer.....	31
4.11	Wiring trailer/semi-trailer.....	32
4.12	Hand-Held Tool, diagnostic cable.....	33
4.13	Spare parts.....	34
<b>5</b>	<b>Installation.....</b>	<b>35</b>
5.1	Scope of supply .....	35
5.2	Disposal of packaging .....	35
5.3	Installation of the tire sensor .....	35
5.4	Installation of the central control unit on the commercial vehicle .....	36
5.5	Installation of an additional receiver (optional).....	39
5.6	Installation of partial wiring harness D from central control unit to additional receiver .....	43
5.7	Installation of partial wiring harness C from central control unit to fuse box.....	45
5.8	Installation of the display (optional).....	46
5.9	Final steps during installation on the commercial vehicle.....	50
5.10	Installation of central control unit and an optional additional receiver on trailer/semi-trailer .....	65
5.11	Installation and orientation of the pressure control indicator .....	67
5.12	Installation of F+G wiring harness from central control unit to pressure control indicator, diagnostic port and distributor box .....	78
5.13	CPC for trailer connected to a third-party system .....	81
5.14	Checks after installation.....	81

<b>6</b>	<b>Initialization using Hand-Held Tool.....</b>	<b>82</b>
<b>7</b>	<b>Test drive for system checking.....</b>	<b>85</b>
7.1	Test drive for system checking on the commercial vehicle.....	85
7.2	Test drive for system checking on semi-trailer.....	87
7.3	Preparation for repeating a test drive.....	88
<b>8</b>	<b>Modification of the system configuration.....</b>	<b>89</b>
8.1	Single Wheel Exchange (SWE).....	89
8.2	Manual adaptations with the Hand-Held Tool.....	91
8.3	Deactivate/activate ContiPressureCheck system.....	92
<b>9</b>	<b>Documentation of system installation.....</b>	<b>93</b>
<b>10</b>	<b>Information on the system.....</b>	<b>94</b>
10.1	General.....	94
10.2	Operation.....	94
<b>11</b>	<b>Diagnosis.....</b>	<b>94</b>
11.1	Error messages and handling instructions.....	95
11.2	Evaluation of reception quality via display.....	98
11.3	Display device information:.....	101

# Table of Contents

---

<b>12</b>	<b>Dismantling and disposal .....</b>	<b>102</b>
12.1	Dismantling .....	102
12.2	Disposal.....	104
<b>13</b>	<b>Declaration of Conformity .....</b>	<b>106</b>
<b>14</b>	<b>Further documents.....</b>	<b>106</b>
14.1	Radio permit .....	106
14.2	General Operating Permit.....	106
14.3	ADR.....	107
<b>15</b>	<b>Index.....</b>	<b>108</b>

# 1 General

In case of doubt, the German version applies.

## 1.1 Information on this installation manual

This installation manual is intended for repair shop personnel with specialist knowledge in vehicle electrics.

Knowledge of its contents enables the system to be installed on commercial vehicles.

This installation manual is a crucial aid to the successful and safe installation of the system. It contains important instructions on installing and operating the system correctly and safely. Observance of the contents will help to avoid dangers and increase the reliability and service life of the system.

The latest installation instructions are available online for anyone ([www.contipressurecheck.com/downloads](http://www.contipressurecheck.com/downloads)).

- Installation,
- Commissioning,
- operation
- and/or diagnosis

of the system.

The instructions contained therein - especially the safety instructions - must be observed.







## 1.2 Liability disclaimer

The manufacturer assumes no liability for damage and operational faults resulting from:

- Failure to observe this installation manual,
- use for other than the intended purpose,
- Employment of unqualified or insufficiently qualified and correspondingly instructed staff,
- Faulty installation,
- not using original replacement and accessory parts,
- technical changes and modifications,

## 1.3 Explanation of symbols

Warnings are additionally identified in this installation manual by warning symbols. The following warning symbols are used in this installation manual:

Symbol	Meaning
	General warning
	Electric shock hazard
	Hazard from health-endangering or irritant substances
	General instructions and useful suggestions on handling
	Note on observing environmental regulations for disposal
	Electric/electronic components with this symbol may not be disposed of in the normal household waste.

## 1.4 Abbreviations





The following abbreviations are used in this installation manual:

Abbreviation	Meaning
ADR	European convention on international carriage of dangerous goods by road ( <b>A</b> ccord <b>e</b> uropéen relatif au transport international des marchandises <b>D</b> angereuses par <b>R</b> oute)
ATL	<b>A</b> uto <b>T</b> railer <b>L</b> earning
BT	Bluetooth
CAN	Data bus system for communication between vehicle systems ( <b>C</b> ontroller <b>A</b> rea <b>N</b> etwork)
CCU	<b>C</b> entral <b>C</b> ontrol <b>U</b> nit
CPC	ContiPressureCheck™
DTC	Error message ( <b>D</b> iagnostic <b>T</b> rouble <b>C</b> ode)
GND	Ground
HHT	<b>H</b> and- <b>H</b> eld <b>T</b> ool
IGN	<b>I</b> gnition
Truck	Commercial vehicle
RSSI	Transmission power of the tire sensors ( <b>R</b> eceived <b>S</b> ignal <b>S</b> trength <b>I</b> ndicator)
Sensor ID	Sensor <b>i</b> dentification number
StVZO	German Road Traffic Licensing Act
SWE	<b>S</b> ingle <b>W</b> heel <b>E</b> xchange
U-bat	Battery voltage



## 1.5 Warnings

The following warnings are used in this installation manual:

	<p style="text-align: center;"><b>⚠ WARNING</b></p> <p><b>Fetching will continued for the next tire.</b> If the hazardous situation is not avoided, it can result in serious injuries.</p> <ul style="list-style-type: none"><li>▶ Follow the instructions in this warning to avoid serious injuries to persons.</li></ul>
	<p style="text-align: center;"><b>⚠ CAUTION</b></p> <p><b>A warning of this category indicates a potentially dangerous situation.</b> If the hazardous situation is not avoided, it can result in injuries.</p> <ul style="list-style-type: none"><li>▶ Follow the instructions in this warning to avoid the danger of serious injury to persons.</li></ul>
	<p style="text-align: center;"><b>ATTENTION</b></p> <p><b>A warning of this category indicates potential danger to property.</b> If the situation is not avoided, it may lead to damage to property.</p> <ul style="list-style-type: none"><li>▶ Follow the instructions in this warning to avoid damage to property.</li></ul>
	<p style="text-align: center;"><b>NOTE</b></p> <ul style="list-style-type: none"><li>▶ A note contains additional information that is important for further processing or for simplifying the procedure step explained.</li></ul>

## 1.6 Copyright protection

This installation manual and all documents supplied with this system are protected by copyright.

These documents may not be duplicated either wholly or in part without the express permission of Continental Reifen Deutschland GmbH.

## 1.7 Warranty terms

The respective relevant "Continental AG terms and conditions" apply with the exception of possible different contractual agreements.

The latest version can be obtained via your CPC supplier.

## 1.8 Manufacturer's address

**Continental Reifen Deutschland GmbH**

Vahrenwalder Str. 9

30165 Hannover

Germany

[www.contipressurecheck.com](http://www.contipressurecheck.com)

## 1.9 Customer service

In the case of technical questions on the system, please contact your CPC supplier or the authorized workshop that installed the CPC system.

## 2 Safety Notes

### 2.1 General

This chapter contains important information on all aspects of safety.

Apart from the general safety instructions given in this chapter, further safety instructions relevant to the operations covered are given in each of the work chapters.

Hazards that could occur during a particular action are described before the instructions for each step.

	<b>⚠ WARNING</b>
	<p><b>Hazard from failure to observe the safety instructions!</b></p> <p>Failure to observe the safety instructions and handling instructions given in this installation manual can create considerable hazards.</p> <p>► Observe the warnings and instructions given here.</p>

### 2.2 Prohibition of modifications

All modifications and changes to the system are prohibited.

The manufacturer assumes no liability for damages resulting from unauthorized modifications

Should modifications or changes to the system nevertheless be necessary, please contact the manufacturer.

## 2.3 Intended use

This system is intended exclusively for

- determining the condition of the individual tires (e.g. tire pressure or tire inside temperature)
- determining the system condition
- providing this information to the user (e.g. via radio or on the display or the vehicle CAN bus).

Use for any other purpose is not considered as intended use.

Operation of the system in a defective physical condition is prohibited.

	<b>⚠ WARNING</b>
	<p><b>Danger resulting from improper use!</b></p> <p>Any use other than and/or going beyond the intended use of the CPC system can lead to dangerous situations.</p> <ul style="list-style-type: none"><li>▶ Use the CPC system only for its intended purpose.</li><li>▶ Comply with all instructions in this installation manual.</li></ul>

No claims of any kind will be accepted for damage resulting from use of the appliance for other than its intended purpose.

The risks associated with such use must be borne solely by the user.

## 2.3.1 Use of the tire sensors

The operator must ensure that tires in which tire sensors are installed are only operated on vehicles in which monitoring is ensured by the system.

If continuous technical monitoring is not assured, the operator must ensure that the condition of the tire sensor is checked at regular intervals, but at the latest every 20,000 km (12,425 miles) or every 6 months.

In the case of continued use of the tires on other vehicles where monitoring is not ensured, the tire sensors must first be removed from the tires.

## 2.4 Fundamental safety instructions

Observe the following instructions to avoid accidents during the installation of the system:

- Observe the vehicle manufacturer's safety instructions.
- Take all necessary precautions, e.g. to prevent rolling away, before jacking up the vehicle.
- Observe the safety at work regulations of the country in question.
- Ensure adequate lighting conditions at the place of work.
- The place of work and the tools used must be in a clean and safe condition.
- Defective parts may only be replaced with original spare parts. Only these parts ensure that the safety requirements are satisfied.
- Check all screw and plug-in connections at regular intervals when using the system.

## 2.5 Particular hazards

	<b>⚠ CAUTION</b>
	<p><b>Danger of short-circuit</b></p> <p>Danger of short-circuits when working on the vehicle electrical system.</p> <ul style="list-style-type: none"> <li>▶ Observe the vehicle manufacturer's safety instructions.</li> <li>▶ Switch off all electrical consumers before disconnecting the battery terminals.</li> <li>▶ Disconnect the minus terminal <b>before</b> the plus terminal.</li> </ul>

- Do not kink cables, place under strain or lay over sharp edges.
- Do not install cables in the vicinity of rotating, moving or hot parts.
- For cables, observe a bending radius of at least 15 mm (0.6 inch), for corrugated tubes a bending radius of at least 35 mm (1.38 inch).
- Ensure that plug connectors are clean and dry, and that they are securely locked after connection.
- Secure the respective wiring harness after appropriately max. 10 cm (3.94 inch) in front of and behind every plug connection.
- Pay attention to effective sealing of the cable feed-throughs in the vehicle cab and in fuse and distributor boxes.
- Use only suitable tools for stripping the cable insulation and for crimping cable shoes.
- Installation of the system on the vehicle (in particular when connecting to the power supply) must not influence the function of other systems on the vehicle (e.g. brake system or light system).

- **Special feature in the case of a vehicle for hazardous materials (ADR):**

If the system is installed on a vehicle for hazardous materials (ADR) and the system remains switched on even when the vehicle ignition is switched off, it is possible that sparks, other ignition sources or similar could lead to a reaction with the hazardous material in the event of a fault.

- Therefore ensure that the power supply to the system is switched off when the vehicle is parked.

## 2.6 Requirements on staff

	⚠ WARNING
	<p><b>Injury hazard with insufficient qualification.</b></p> <p>Improper use can result in considerable damage to persons or property.</p> <p>▶ All activities shall only be carried out by qualified staff.</p>

The following qualifications are specified in this installation manual:

- **Qualified staff**  
 are capable of independently carrying out the work assigned to them and of recognizing and avoiding possible dangers due to their technical training, know-how and experience and their knowledge of the relevant regulations.

The system may only be installed by persons who have been trained for this work and who have technical know-how of vehicle electrics.



## 2.7 Personal protective equipment

	<b>⚠ WARNING</b>
	<p><b>Risk of injury due to wrong or missing protective equipment!</b></p> <p>Personal protective equipment must be worn during installation in order to minimize health risks.</p> <ul style="list-style-type: none"><li>▶ Wear the necessary protective equipment for the work involved during the installation.</li><li>▶ Pay attention to all notices on personal protective equipment within the work area.</li></ul>

Wear the following protective equipment during installation:

Symbol	Meaning
	Wear protective goggles.
	Wear protective gloves.
	Wear safety shoes.

### 3 Technical data

<b>i</b>	<b>NOTE</b>
	<p>► All components to be installed on the vehicle are designed for an operating temperature range of -40 °C to 85 °C (-40 °F to 185 °F). If other temperature ranges apply for the individual components, this is indicated specifically in the following sub-sections.</p>

#### 3.1 Tire sensor

##### 3.1.1 Generation 1:

Dimensions (L x W x H)	38 x 28 x 22 1.5 x 1.1 x 0.87	mm inch
Weight	26 0.92	g oz
Cover colour:	black	
Transmission frequency	433.92	MHz
Reception frequency	125	kHz
Typical service life* of the permanently installed battery approx.	6 or 600 000 372 820	years  km miles
Temperature measuring range	-40 to 120 -40 to 248	°C °F
Pressure measuring range (rel.)	0 to 12 0 to 173	bar psi

\* High temperatures during storage and operation can shorten the battery service life.

# Technical data

---

## 3.1.2 Generation 2:

Dimensions (L x W x H)	38 x 28 x 22 1.5 x 1.1 x 0.87	mm inch
Weight	26 0.92	g oz
Cover colour:	orange	
Transmission frequency	433.92	MHz
Reception frequency	125	kHz
Bluetooth (active only at standstill)	2.4	GHz
Typical service life* of the permanently installed battery approx.	4	years
	or 600,000 372,820	km miles
Measuring range		
- Temperature	-40 to 120 -40 to 248	°C °F
- Pressure (rel.)	0 to 12 0 to 173	bar psi
Temperature range		
- Tire sensor	-40 to 120 -40 to 248	°C °F
- Bluetooth	-10 to 105 +14 to 221	°C °F

\* Differences in battery service life are possible, depending on the application profile, as the sensor behavior depends on the momentary driving speed. High temperatures and frequent connection to the sensor via bluetooth during storage and operation can shorten the battery service life.

### 3.2 Central control unit

Dimensions (L x W x H)	165 x 121 x 65 6.5 x 4.76 X 2.56	mm inch
Weight	390 13.76	g oz
Supply voltage	12/24	V
Reception frequency	433.92	MHz
Mating cycles	min. 10	cycles

### 3.3 Additional receiver (optional)

Dimensions (L x W x H)	90 x 42 x 28 3.54 x 1.65 x 1.1	mm inch
Weight	44 1.55	g oz
Frequency	433.92	MHz
Mating cycles	min. 10	cycles

# Technical data

---

## 3.4 Display

Dimensions (L x W x H)	117 x 107 x 40 4.60 x 4.21 x 1.57	mm inch
Weight	240 8.47	g oz
Supply voltage	12/24	V
Mating cycles		
- Connecting plug diagnosis	min. 100	cycles
- Connection plug supply	min. 10	cycles
- Connecting plate bracket to display	at least 5	cycles
Temperature range	-40 to 85 -40 to 185	°C °F
Legibility of the display without impairment	-20 to 80 -4 to 176	°C °F

### 3.5 Hand-Held Tool

Dimensions (L x W x H)	160 x 84 x 33 6.3 x 3.31 x 1.30	mm inch
Weight	325 11.46	g oz
Charger supply voltage	220/110	V
Low frequency	125	kHz
High frequency	433.92	MHz
Mating cycles: - Plug to Hand-Held Tool	min. 1000	cycles
- All 3 plugs to vehicle components	min. 100	cycles
Operating temperature range	-5 to 50 23 to 122	°C °F
Storage temperature range	-20 to 25 -4 to 77	°C °F

### 3.6 Pressure control indicator

Dimensions (L x W x H)	140 x 140 x 160 5.51 x 5.51 x 6.3	mm inch
Weight	115 4.06	g oz
Supply voltage	12/24	V
Mating cycles	min. 100	cycles

## 4 Design and Function

### 4.1 Description of functions

The system allows i.a. continuous monitoring of the tire pressure and tire temperature. The status is shown on the display. In the event of a pressure drop in a tire, the driver immediately receives a corresponding warning.

The basic system consists of a display, the central control unit (CCU), and the tire sensors. Each tire sensor fixed on the inside of the tire, transmits the measured data via a radio signal to the central control unit. The analyzed data are then transmitted via the CAN bus system to the display in the driver's cab. The driver can display the required information at any time and so permanently monitor the current temperature and pressure of the tires. In the case of a deviation from the programmed value of the associated target pressures, warning is shown on the display.

### 4.2 Overview

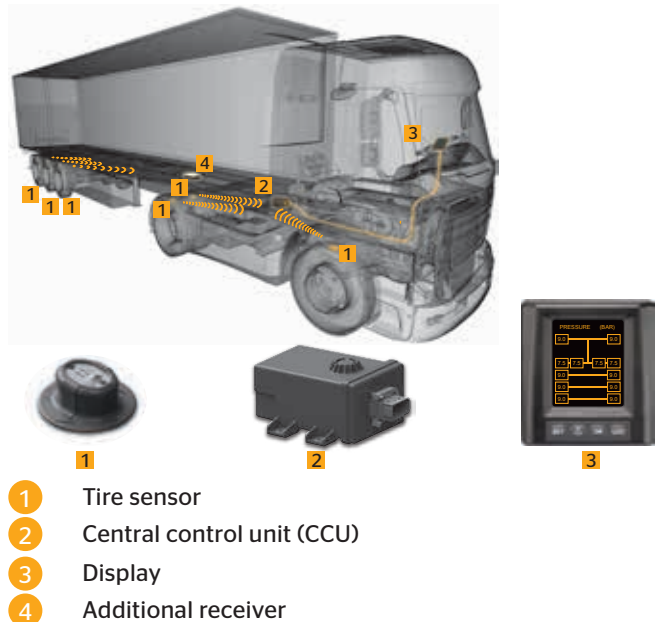

## 4.3 Configurations

There are 2 configurations of the CPS system:

- CPC for commercial vehicles
- CPC for trailers/semi-trailers

### **CPC for commercial vehicles:**

This means trucks and buses, but also other special vehicles.

With this configuration, the central control unit (CCU) and the additional receiver are on the indicated vehicle types.

For this configuration, use the CCU with the black plug.

With appropriate positioning and orientation of the additional receiver, monitoring of the tire sensors installed in trailer tires is also possible (see „**5.5.1 Requirements for optimum reception**“).

### **CPC for trailers/semi-trailers:**

With this configuration, the central control unit (CCU) and the additional receiver are on the trailer/semi-trailer.

For this configuration, use the CCU with the gray plug.

This configuration is intended only for monitoring the tire sensors installed on the same vehicle.



## 4.4 Tire sensor

The tire sensor comprises a pressure sensor, temperature sensor, acceleration sensor, microprocessor, radio transmitter and lithium battery. The unit is molded in a plastic housing and is introduced into a tire sensor container.

The tire sensor container is attached to the inner ply of the tire (see also Installation instructions - tire sensor container with REMA TipTop or Installation instructions - tire sensor container with Cyberbond).

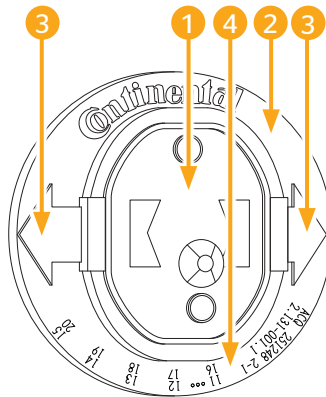

- 1** Tire sensor
- 2** Tire sensor container
- 3** Direction of tire rotation
- 4** Quarter and year of manufacture

There are 2 versions of the tire sensor:

- Black cover: Generation 1
- Orange cover: Generation 2

The Generation 2 tire sensor has a Bluetooth interface.

The system is designed to function with both tire sensor generations.

## 4.5 Central control unit (CCU)

The data recorded by the tire sensor are transmitted by radio to the central control unit.

Receipt of these radio signals is ensured by an antenna integrated into the housing of the control unit which ensures interference-free reception of the pressure and temperature signals from all the tire sensors.

The central control unit is designed for operation in a 12/24 Volt system.

The central control unit is installed in a central position on the vehicle chassis so that interference-free reception of the tire sensor radio signals is ensured. Use of the bracket provided is recommended for good radio reception (see section „4.8 Holder“).

There are two versions of the central control unit:

- Control unit with black plug:  
without control of the pressure control indicator
- Control unit with gray plug:  
with control of the pressure control indicator

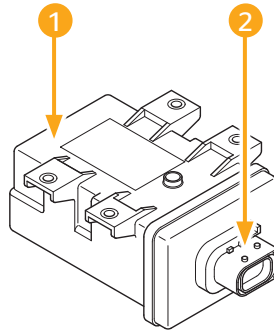

- 1 Housing
- 2 Connecting plug

The system can manage up to 32 tire sensors per control unit. Faults occurring during operation are stored in the electronics for diagnostic purposes.

## 4.6 Additional receiver (optional)

An additional receiver is required:

- In case of longer distances (above approx. 4 m (4.4 yd)) between tires and central control unit.
- if the system installed on the tractor unit is also to monitor the trailer.
- on vehicles with more than 2 axles.
- on buses

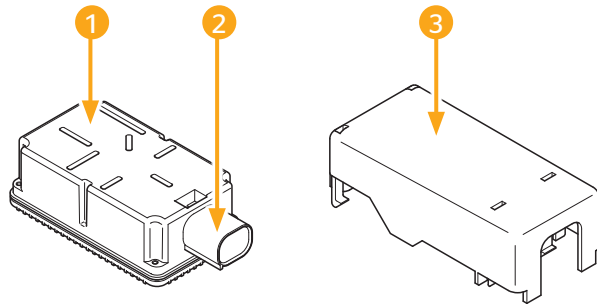

- 1 Housing
- 2 Connecting plug
- 3 Impact guard

The additional receiver **must always** be used with the impact guard.

NOTE	
	<p>If the impact guard is not used,</p> <ul style="list-style-type: none"><li>▶ the ContiPressureCheck™ system may not be used for transporting hazardous materials (see chapter „<b>14.3 ADR</b>“).</li><li>▶ damage to the additional receiver is possible.</li><li>▶ the reception range of the additional receiver is reduced.</li></ul>

## 4.7 Display

A display is installed in the driver's cab to show the tire information. The pressure control indicator must be used for systems installed on the trailer (see „4.10 Pressure control indicator trailer/semi-trailer“)

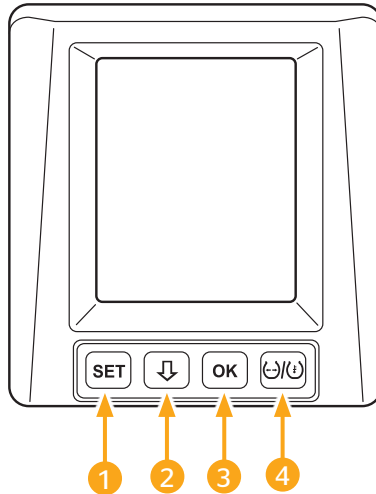

- 1 **SET** button: Switchover between vehicle view and settings
- 2 button: Navigation between menu items and warnings
- 3 **OK** button: Confirmation of the selected menu item
- 4 button: Switchover between filling pressure and temperature display

On the rear side are the jacks for:

- Power supply and communication
- Diagnostic cable

	NOTE
	<p>► The display operates reliably in a temperature range from -20 °C to 80 °C (-4 °F to 176 °F). At temperatures below -20 °C (-4 °F) or above 80 °C (176 °F), the display may be impaired.</p>

## 4.8 Holder

### 4.8.1 Holder for the central control unit

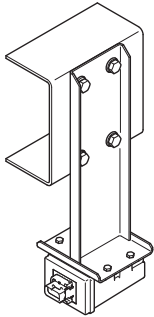

A special bracket is required for installation of the central control unit on the vehicle chassis in order to ensure good reception of the tire sensor radio signals.

NOTE	
<b>i</b>	<ul style="list-style-type: none"><li>▶ Screws, washers and nuts for attachment of the central control unit to the holder are included in the installation kit.</li><li>▶ Screws for installation on the chassis are not included in the installation kit.</li></ul>

### 4.8.2 Holder for the additional receiver (optional)

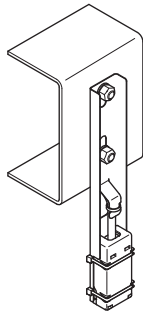

A special bracket is required for installation of the additional receiver (and corresponding impact protection device) on the vehicle chassis in order to ensure good reception of the tire sensor radio signals.

NOTE	
<b>i</b>	<ul style="list-style-type: none"><li>▶ Screws for installation on the chassis are not included in the installation kit.</li><li>▶ The original bracket must be used as the mounting of the receiver and the impact guard are matched to the bracket.</li></ul>

## 4.9 Commercial vehicle cabling

- **Partial wiring harness C:**  
Partial wiring harness C comprises the connection of the central control unit to a distribution point in the vicinity of the driver's workplace. This section is splash water-proof so that it can be laid on the outside of the vehicle.
- **Partial wiring harness A and B:**  
Partial wiring harness A (with integrated fuse) and B are only conceived for enclosed spaces. A wiring set to the display (Partial wiring harness B), and a wiring set with free cable ends for connection to the supply voltage of the vehicle (Partial wiring harness A).

Adapter cable for additional receiver:

- **Partial wiring harness D (optional):**  
The additional receiver (optional) is connected to the central control unit by means of partial wiring harness D.

The basic principle of the wiring on the commercial vehicle with additional receiver is shown in the following figure:

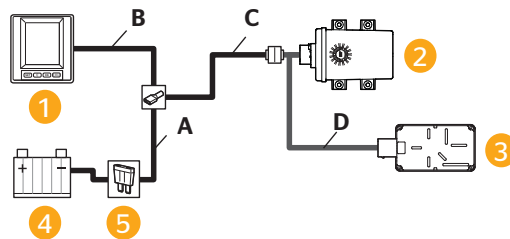

- 1 Display
- 2 Central control unit (CCU)
- 3 Additional receiver (optional)
- 4 Power supply (fuse box)
- 5 ATO fuse 1 ampere - exchangeable

## 4.10 Pressure control indicator trailer/semi-trailer

The trailer/semi-trailer can be operated with a separate central control unit independent of the towing vehicle. In this case, a pressure control indicator is installed on the outside of the trailer.

An example of the positioning of the pressure control indicator is shown in the following figure:

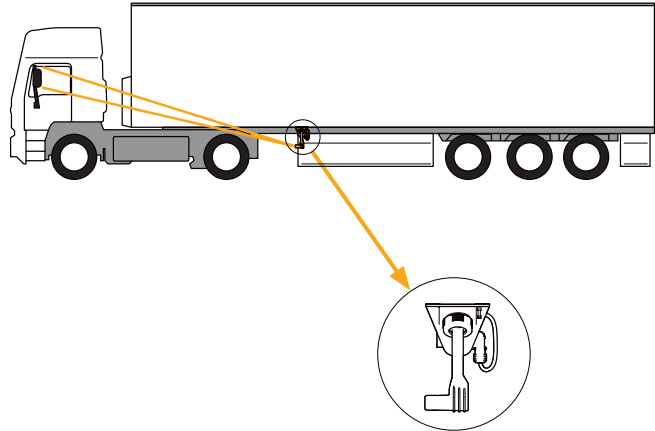

<b>i</b>	<b>NOTE</b>
	<p>► Above a speed of 110 km/h (70 mph) the visibility of the pressure control indicator may be restricted.</p>

## 4.11 Wiring trailer/semi-trailer

- Wiring harness F + G:**  
 Wiring harness F + G connects the central control unit to the vehicle power supply (branch F) and the port for the Hand-Held Tool/pressure control indicator (branch G).
- Partial wiring harness H (optional):**  
 Connection of the additional receiver (optional) with the central control unit takes place via partial wiring harness H.

The basic wiring principle for the trailer/semi-trailer with additional receiver is illustrated in the following diagram:

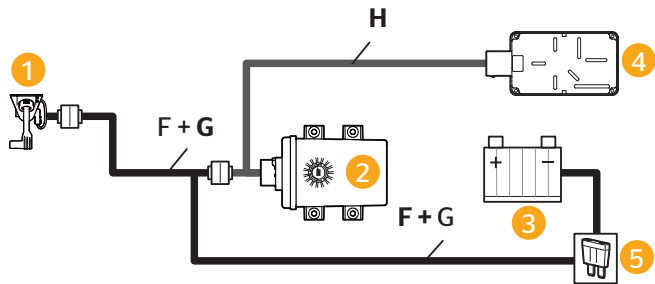

- 1 Pressure control indicator
- 2 Central control unit
- 3 Power supply (distributor box)
- 4 Additional receiver (optional)
- 5 1 ampere ATO fuse - exchangeable (included in the mounting kit)



## 4.12 Hand-Held Tool, diagnostic cable

After installation, the system is initialized using the Hand-Held Tool.

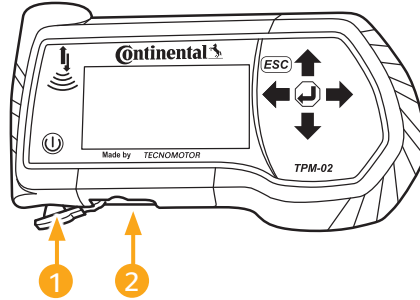

- 1 Charging cable port
- 2 USB and diagnostic cable port

The Hand-Held Tool is connected to the display or to the diagnostic plug of the trailer by means of the diagnostic cable. A port is provided for this on the housing of the display and of the Hand-Held Tool. The diagnostic plug of the trailer is the mating plug of the pressure control indicator (see branch G or wiring harness F+G).

NOTE	
	<ul style="list-style-type: none"><li>▶ The Hand-Held Tool works safely in a temperature range from -5 °C to 50 °C (23 °F to 122 °F). At temperatures below -5 °C (23 °F) or above 50 °C (122 °F), the display and transmitting power may be impaired.</li><li>▶ Comprehensive operating instructions for the Hand-Held Tool can be found under <a href="http://www.contipressurecheck.com/downloads">www.contipressurecheck.com/downloads</a> in the manual of the Hand-Held Tool.</li></ul>

### 4.13 Spare parts

An over of available spare parts and the associated article numbers can be obtained from your CPC supplier or from authorized CPC partner workshops.

## 5 Setup

### 5.1 Scope of supply

	NOTE
	<ul style="list-style-type: none"><li>▶ Check the entire delivery for completeness and visual damage.</li><li>▶ On delivery of the system, note any damage due to improper packaging or transport damage on the delivery note and report it to your sales contact immediately.</li></ul>

### 5.2 Disposal of the packaging

The packaging protects the system against transport damage. The packaging materials have been selected in line with environmental and disposal aspects and are therefore recyclable.



Returning the packaging to the material cycle saves raw materials and reduces the production of waste. Dispose of packaging materials no longer required in accordance with the local regulations.

### 5.3 Installation of the tire sensor

For installation of the tire sensor, please refer to the manuals "Installation instructions - tire sensor container with REMA TipTop" and "Installation instructions - tire sensor container with Cyberbond".

## 5.4 Installation of the central control unit on the commercial vehicle

	ATTENTION
	<p><b>Damage to the control unit!</b></p> <p>When selecting a suitable installation location, observe the following points to avoid damage to the control unit:</p> <ul style="list-style-type: none"> <li>▶ Avoid installing near sources of heat (e.g. exhaust system) or rotating or moving parts.</li> </ul>

### 5.4.1 Determining the installation location on the longitudinal member of the truck

- The unit should be installed mid-way between the first and last axle.
- To ensure good reception of the tire sensor radio signals, install the bracket so that the central control unit extends as far as possible under the longitudinal member (maintain safety distances e.g. to the road). For good wireless connection, the central control unit must not be shielded by metal walls in the immediate vicinity.
- Choose the gap to the driver's cabin so that the length of partial wire harness C (9 m/ 9.8 yd) ranges into the fuse box.

	NOTE
	<ul style="list-style-type: none"> <li>▶ The protruding length of the bracket (gap: Lower edge of chassis frame to control unit) must not exceed 12 cm (4.72 inch) (see chapter „5.4.2 Mounting“).</li> </ul>

## 5.4.2 Mounting

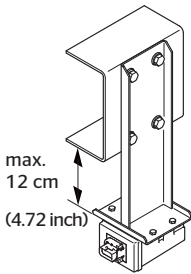

- For fixing the holder to the I-beam, use at least 2 of the suitable holes provided. Measure the distance between the existing holes, transfer to the holder and install.
- Mount the central control unit on the holder using the mounting material included in the installation kit. Align the central control unit so that the plug-in connection points to the rear of the vehicle.

NOTE	
<b>i</b>	▶ If the installation situation does not otherwise allow, it is possible to align the control unit with the plug-in connection to the side of the vehicle. However, in this case, damage to the plug / plug-in connection by flying stones cannot be ruled out.

- Use suitable installation materials (bolts min. M 10, strength class min. 8.8, self-locking nuts and washers dia.  $\geq 24$  mm) for attachment to the longitudinal members.  
Preferably, fixing should take place with 4 screws. If this is not possible, fixing must take place according to the illustration below.

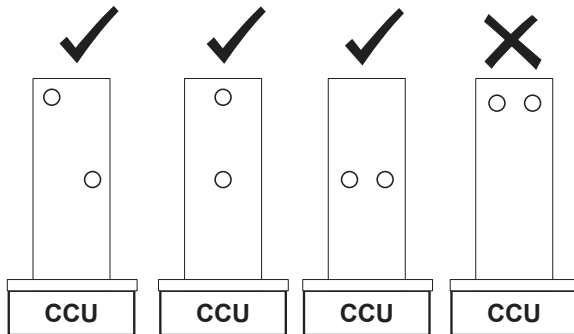

Examples for fixing with 2 screws (the example on the right is a negative example).

### 5.4.3 Installation location on the bus

In the case of the bus, an additional receiver is always required.

Install the central control unit, preferably on the chassis. If this is not possible, both components can be installed in the trunk. Both components may not be shielded by metal walls to the tire sensor.

- Install the central control unit in the trunk as closed as possible to the front axle.
- Attach the additional receiver as near to the rear axle/s as possible.

## 5.5 Installation of an additional receiver (optional)

On vehicles with a large wheelbase and vehicles with more than 2 axles, an additional receiver is necessary to improve the reception quality of the tire sensor radio signals.

	ATTENTION
	<p><b>Damage to the additional receiver!</b></p> <p>When selecting a suitable installation location, observe the following points to avoid damage to the additional receiver:</p> <ul style="list-style-type: none"><li>▶ Avoid installing near sources of heat (e.g. exhaust system) or rotating or moving parts.</li></ul>

	NOTE
	<ul style="list-style-type: none"><li>▶ If an additional receiver is installed, the central control unit must be attached in the vicinity of the front axle and the additional receiver at the rear of the vehicle.</li></ul>

### 5.5.1 Requirements for optimum reception

The reception area of the additional receiver is similar to that of cone, whereby the reception quality decreases as the gap to the tire sensors increase. Reception is restricted in the area behind the holder (see illustration below).

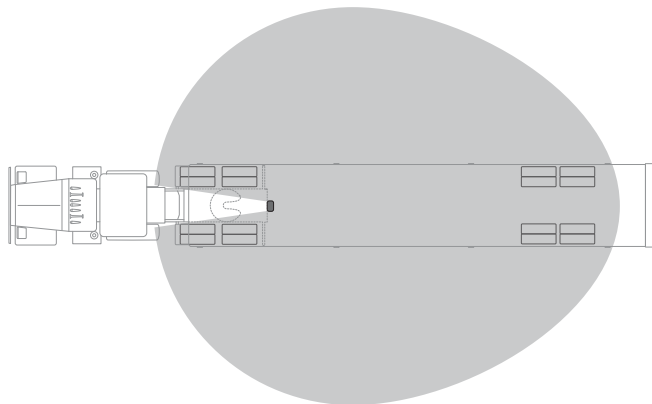

The optimum position of the additional receiver is

- in the middle of at the rear of the vehicle
- and
- with the smallest possible gap to the floor (observing safety gaps, e.g. to the road).

Ideally, this allows direct line of sight between the additional receiver and the side walls of all tires to be monitored.

NOTE	
<b>i</b>	<ul style="list-style-type: none"> <li>▶ If the additional receiver is attached offset to the side, so that the front face points to the running surfaces of some of the tires, there is risk that reception of the sensor signals from these tires could be impaired.</li> </ul>



## 5.5.2 Positioning the additional receiver

The preferred installation location for the additional receiver is the rear of the vehicle, particularly when the trailer also has to be monitored.

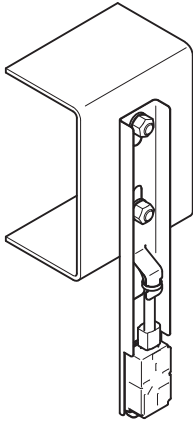

- The holes for fitting the holder of the additional receiver are drilled according to the hole pattern of common semi-trailers in Europe. If the corresponding hole pattern is not available, look for other suitable holes at the rear of vehicle and insert into the holder.

NOTE	
	<ul style="list-style-type: none"><li>▶ The additional receiver should be mounted so that there is no metal directly behind it. This could impair the reception quality.</li></ul>

- The holder should be mounted so that the open side of the U profile points to the trailer and the additional receiver has the smallest possible gap to the ground (observing safety gaps, e.g. to the road). Due to the quasi cone-shaped reception characteristics, not only the trailer tires are monitored in this case, but also the rear axles of the towing vehicle.
- Attach the holder with suitable fixing material (at least manufacturing class 8.8 screws as well as self-locking nuts and washers). Attach the additional receiver with the plug connector facing upwards.

### 5.5.3 Mounting the impact guard on the additional receiver

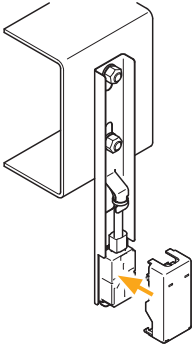

After connecting partial wire harness D with the additional receiver (see chapter „5.6 *Installation of partial wiring harness D from the central control unit to the additional receiver*“), the impact guard must be mounted.

- ◆ Place the impact guard over the additional receiver and anchor it in the holder.

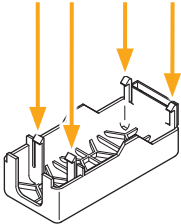

- ◆ Insert the 4 snap hooks into the corresponding openings of the bracket and press the impact guard against the bracket so that all 4 snap hooks are engaged.

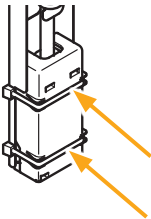

- ◆ Secure the impact guard with two cable binders (not supplied a standard) as illustrated.



#### NOTE

If the impact guard is not used,

- ▶ The ContiPressureCheck™ system must not be used on vehicles transporting hazardous materials (see section „14.3 ADR“).
- ▶ damage to the additional receiver is possible.
- ▶ the reception range of the additional receiver is reduced.

## 5.6 Installation of partial wiring harness D from the central control unit to the additional receiver

	<b>ATTENTION</b>
	<p><b>Damage to the wiring harness!</b></p> <p>When laying the wiring harness, observe the following points to avoid damage to the harness:</p> <ul style="list-style-type: none"><li>▶ Avoid installing near sources of heat (e.g. exhaust system) or rotating or moving parts.</li></ul>

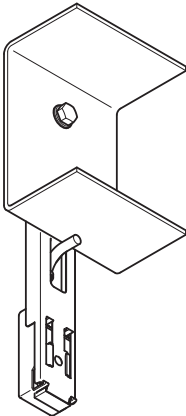

Partial wire harness D of the additional receiver is supplied with water-proof plugs.

- ◆ First connect the cable to the central control unit.
- ◆ Lay the cable along the existing wiring harness of the vehicle and fasten loosely with cable straps.
- ◆ Insert the plug of the additional receiver into the holder from the back and attach to the receiver.

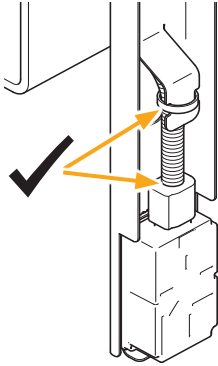

- ◆ Push the corrugated pipe onto the plug until it stops and then fix to the protruding metal latch with a cable binder. If properly mounted, only 3 wires are visible (see adjacent examples).

- ◆ Secure the cable along the vehicle wiring harness sufficiently with cable straps.

- ◆ At the bracket of the central control unit, secure the T-piece of partial wiring harness D to the bracket using a cable tie.

- ◆ Lay the excess cable in loops and secure with at least two cable straps.

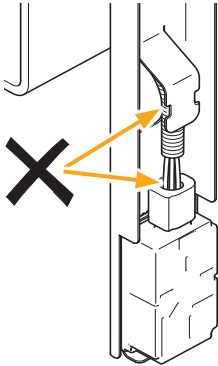

For the plug connection on the central control unit and to partial wire harness C, the following is recommended:

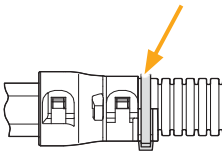

- ◆ Fix the corrugated pipe at the input for covering the plug with an additional cable binder (see arrow) so that the corrugated pipe cannot detach itself from the connector cover in unfavorable conditions.

## 5.7 Installation of partial wiring harness C from the central control unit to the fuse box

	<b>ATTENTION</b>
	<p><b>Damage to the wiring harness!</b></p> <p>When laying the wiring harness, observe the following points to avoid damage to the harness:</p> <ul style="list-style-type: none"><li>▶ Avoid installing near sources of heat (e.g. exhaust system) or rotating or moving parts.</li></ul>

- ◆ Connect the 8-pin plug of partial wiring harness C to the central control unit or to the mating plug of partial wiring harness D (if used).
- ◆ From there, lay the cable along the existing wiring harness of the vehicle to the driver's cab and fasten loosely with cable straps.
- ◆ Lay the wiring harness to the fuse box of the vehicle (see also vehicle operating manual).
- ◆ Finally secure the cable along the vehicle wiring harness with cable straps once again.

or the plug connection at the central control unit or to partial wire harness D, the following is recommended:

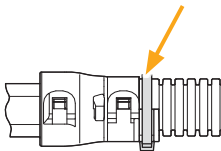

- ◆ Fix the corrugated pipe at the input for covering the plug with an additional cable binder (see arrow) so that the corrugated pipe cannot detach itself from the connector cover in unfavorable conditions.

## 5.8 Mounting the display (optional)

	<b>⚠ WARNING</b>
	<p><b>Risk of injury!</b></p> <p>The risk of injury cannot be ruled out if the installation instructions are not followed.</p> <ul style="list-style-type: none"> <li>▶ Mount the display offset to the side of the driver and the front passenger(s).</li> <li>▶ Do not mount the display in the impact zone of the body or the head and not in the airbag area (driver &amp; front passenger).</li> </ul>

	<b>NOTE</b>
	<p><b>The vehicle driver must have a sufficient field of view under all operating and weather conditions.</b></p> <ul style="list-style-type: none"> <li>▶ Mount the display so that the field of view of the driver is not restricted.</li> </ul>

## 5.8.1 Display holder with suction caps for attaching to the windscreen

To attach the display to the windscreen to the display holder, use the suction caps.

- ◆ Connect the display with the display holder supplied. Make sure that the display is completely snapped and locked into the holder.
- ◆ Choose a suitable location on the windscreen. Pay attention to possible dazzling by sunlight.

	<b>NOTE</b>
	<p><b>National regulations!</b></p> <p>▶ If national regulations stipulate that devices may no be attached to the windscreen, mount the display with the holder according to chapter „<b>5.8.2 Display holder for screwing to the dashboard</b>“</p>

### 5.8.2 Display holder for screwing to the dashboard

To mount the display to the dashboard, glue **and** screw the display holder to the dashboard.

- ◆ Connect the display with the display holder supplied.
- ◆ Chose a suitable location on the dashboard. Pay attention to possible dazzling by sunlight.

	ATTENTION
	<p><b>Damage!</b></p> <p>If the display holder is screwed on incorrectly, vehicle components or cables in the dashboard may be damaged:</p> <ul style="list-style-type: none"> <li>▶ Before screwing tight, make sure that components or cables cannot be damaged when fixing the display holder.</li> </ul>



- ◆ Remove the display from the holder.
- ◆ Pull off the protective foil of the contact surfaces on the holder and glue the holder to the desired location.
- ◆ Also screw the holder into the dashboard with the 2 screws supplied.
- ◆ Connect the display with the display holder supplied. Make sure that the display is completely snapped and locked into the holder.

	<b>NOTE</b>
	<p><b>It is recommended to fix the display by gluing and screwing!</b></p> <ul style="list-style-type: none"><li>▶ The adhesive foil compensates unevenness between the holder and installation location and ensures a tighter fit.</li><li>▶ The screws secure the holder against vibration during operation and therefore against unintentional loosening.</li></ul>

	<b>NOTE</b>
	<p><b>Dismantling the display holder!</b></p> <ul style="list-style-type: none"><li>▶ After dismantling the display holder, two holes remain in the dashboard. In addition, residual adhesive could remain on the dashboard.</li></ul>

### 5.9 Final steps during installation on the commercial vehicle

	ATTENTION
	<p><b>Danger of short-circuit</b></p> <p>▶ Switch off the ignition before starting work.</p>

When installed in a commercial vehicle, the CPC system can be operated in 2 ways:

- **CPC as independent system**  
 The status of the tires and the warnings are shown on in the CPC display.  
 Installation instructions: Chapter „**5.9.1 CPC as independent system**“.
- **Connection of the CPC system to a third-party system**  
 (e.g., telematics system, dashboard display or vehicle CAN bus)  
 The status of the tires, the warnings ad the error messages must then be displayed on another display device.  
 Installation instructions: Chapter „**5.9.2 Connection of the CPC system to a third-party system**“.

## 5.9.1 CPC as independent system

Basic principle of the wiring:

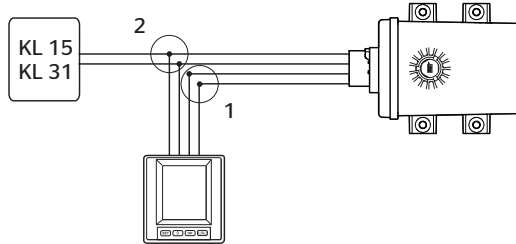

A plug-in connector is used for 2 wires respectively:

- **Plug-in connector 1** (white):  
Wires are brown and white
- **Plug-in connector 2** (black):  
Wires are red and black

Proceed as follows for installation:

- ◆ Identify a suitable cable feedthrough behind the instrument panel from the display to the fuse box; components of the instrument panel may have to be loosened for this (see operating manual of the vehicle).
- ◆ Lay partial wire harness behind the dashboard. Lay the open end from the instrument panel to the fuse box.
- ◆ Secure the cable sufficiently with cable straps.
- ◆ Secure loosened parts of the instrument panel again.
- ◆ In the fuse box, identify terminals 15 (ignition - IGN) and the ground cable terminal 31 (ground cable - GND). Pay attention to the special instructions in the vehicle operating manual.
- ◆ Lay partial wiring harness A from the fuse box to cables B and C. The integrated fuse remains in the wiring harness.



### ATTENTION

#### Danger of short-circuit

Risk of short-circuit if the fuse is not installed.

- ▶ Do not shorten the supply line A on the fuse side.

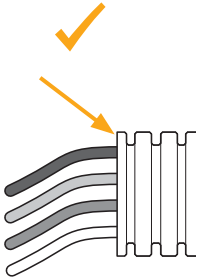

- ◆ Shorten partial wire harnesses B and C to the required length, if necessary.



### NOTE

- ▶ Shorten the corrugated pipe on the wiring harness in "upper" areas and not "lower" areas as shown in the adjacent illustration. Otherwise there is a risk that wires routed on the inside could fray in the "lower" edge during operation.

- ◆ First fit spade connectors to the two CAN terminals (brown/white) of partial wiring harness C of the central control unit and install the connector housing. Polarity of the wires as shown in the adjacent illustrated.

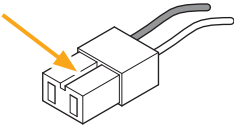

The notch (see arrow left) serves as reverse polarity protection.

(The spade connectors and the plug housing are included in "Plug set A+B+C".)

- ◆ Then fit flat connectors to display partial wire harness B and mount the plug housing. The polarity from connector to socket must correspond. The notch (see arrow left) serves as reverse polarity protection.

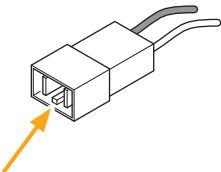

- ◆ Connect the two white plugs together. Check the polarity of the wires by comparing the colors, correct if necessary.

- ◆ In the following step, fit flat connectors to the red and black wires of partial wire harnesses B and C and mount the black plug housings.  
The polarity of the plugs is already prescribed by partial wire harness A.  
(The flat plugs and the plug housings are included in "Connector set A+B+C".)
- ◆ Subsequently connect the black plugs of partial wire harnesses A, B, and C with each other.
- ◆ Connect partial wire harness A to terminal 15 (ignition - red) and terminal 31 (ground cable - black).
- ◆ Subsequently lock the fuse box again properly. Take into consideration that the original sealing of the fuse box must be ensured after completing the installation.
- ◆ Connect the plug of the wiring harness to the display.
- ◆ Secure loosened parts of the instrument panel again.

	NOTE
	<p>► If the CPC system is used as an independent system, please use the Hand-Held Tool with "<b>Installation - New Installation</b>" or "<b>Modification - Modify Installation - Modify Parameters</b>" for the CAN bus format to select the "CPC+J1939" setting.</p>

## 5.9.2 Connection of the CPC system to a third-party system

### 5.9.2.1 Safety instructions when using the CPC system connected to third-party system

	<b>⚠ WARNING</b>
	<p><b>Risk of injury!</b></p> <p>If the CPC system is connected to a safety-related CAN bus, the safety-related CAN messages can be influenced. This can result in accidents and serious injuries.</p> <p>▶ If the CPC system is connected to a safety-relevant CAN bus, the risk and responsibility lies with the fitter.</p>

The system designed so that all necessary warnings and error messages are shown to the driver on the display or via the pressure control indicator as quickly as possible.

If the system is used in conjunction with a third-party system and the display or the pressure controller indicator is not used, then:

- The operator must ensure that the driver is notified appropriately and as quickly as possible when warnings or error messages occur.

	NOTE
	<ul style="list-style-type: none"><li>▶ In the case of high-level warnings (see table on following page) and error messages, the driver <b>must</b> be notified appropriately when the warning / error message occurs.</li><li>▶ In the case of low-level warnings (see table on following page), the driver <b>should</b> be notified appropriately when the warning occurs.</li></ul>

The following table provides an overview of possible warnings.

For detailed information and handling instructions on warnings, see the corresponding section in the system ***user manual***.

	NOTE
	<ul style="list-style-type: none"><li>▶ For details on possible error messages, see chapter „<i><b>11.1 Error messages and handling instructions</b></i>“.</li></ul>

Priority:	Level	Symbol	Warning message	Fault
High  Low	High	 3*)	Pressure loss	Continuous, fast pressure loss. Tire damage or even tire destruction is possible.
		 1*), 2*)	Severe low pressure.	The tire pressure falls below the recommended alarm threshold value. Tire damage or even tire destruction is possible.
		 2*)	Check Sensor	The tire sensor is no longer properly fixed.
	Low	 1*)	Low pressure	The tire pressure falls below the recommended alarm threshold value. The tire could be damaged in the long term.
			Temperature	The measured temperature in the tire exceeds 115 °C (239 °F). The tire sensor no longer functions at 120 °C (248 °F).
		 4*)	Pressure diff.	The pressure between two twin tires exceeds a fixed threshold. The tires could wear out differently in the long term.
			No reception	Due to insufficient signal strength, it is not possible to display a sensor protocol.
	Sensor defect	Tire sensor defective		

1\*) Pressure value is only an example, threshold values can be stored according to the manufacturer's instructions by a specialist garage

2\*) High warning levels are indicated by flashing symbols changing between positive and negative mode.

3\*) The display changes between the symbol shown and the pressure value.

4\*) The symbol of the pressure difference warning message is displayed for the two affected twin tires between which the pressure difference was detected.



## 5.9.2.2 Connecting the CPC system to a third-party system

The system has 2 CAN termination resistors. One in the central control unit (CCU) and at the open end of partial wire harness L (marked by the red shrink tube).

Connection of the CPC system to a third-party system requires prior checking and adherence to the following points:

- With the help of the documentation on the third-party system, check whether and which of the two CAN termination resistors of the system are required.
- Observe the specifications of SAE J1939-15, particularly with respect to the permissible lengths of the CAN lines and the branch lines.

	<b>NOTE</b>
	► If the display is also to be used, take into account that one CAN termination resistor is also located in the display. This <b>cannot</b> be deactivated.

### Basic principle of the wiring

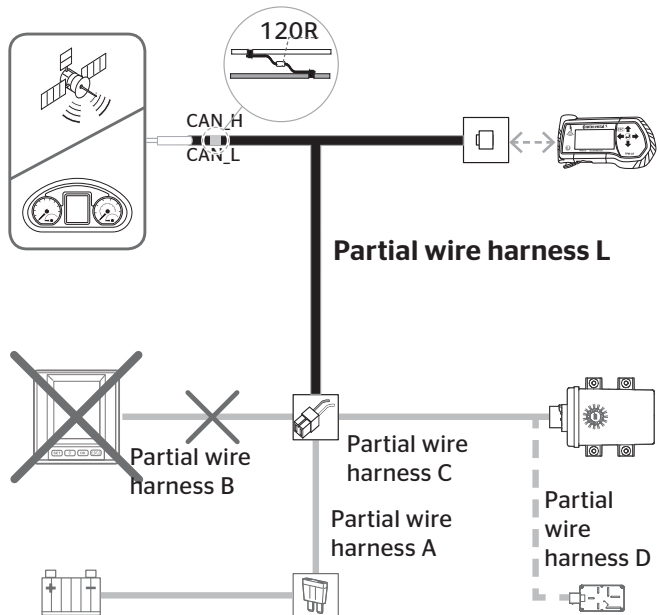

### Basic principle of the wiring

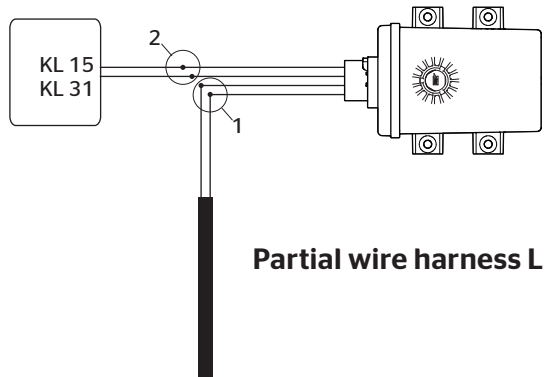

A plug-in connector is used for 2 wires respectively:

- **Plug-in connector 1 (white):**  
Wires are brown and white
- **Plug-in connector 2 (black):**  
Wires are red and black

Proceed as follows for installation:

- ◆ Find a suitable cable feedthrough to the fuse box; it may be necessary to disconnect all components (for this purpose, see the operating manual of the vehicle).
- ◆ In the fuse box, identify terminals 15 (ignition - IGN) and the ground cable terminal 31 (ground cable - GND). Pay attention to the special instructions in the vehicle operating manual.
- ◆ Lay partial wiring harness A from the fuse box to cables B and C. The integrated fuse remains in the wiring harness.
- ◆ Secure the cable sufficiently with cable straps.



## ATTENTION

### Danger of short-circuit

Risk of short-circuit if the fuse is not installed.

- ▶ Do not shorten the supply line A on the fuse side.

- ◆ Shorten partial wire harness C to the required length, if necessary.

If partial wire harness C represents a branch line in the CAN bus network, keep this as short as possible (see specifications from SAE J1939-15).

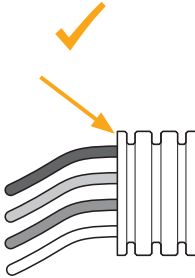

## NOTE

- ▶ Shorten the corrugated pipe on the wiring harness in "upper" areas and not "lower" areas as shown in the adjacent illustration. Otherwise there is a risk that wires routed on the inside could fray in the "lower" edge during operation.

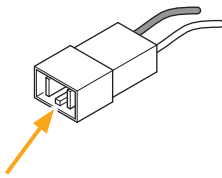

- ◆ For the connection of the CAN lines, the polarity is specified by the white plug on partial wire harness L. The notch (see arrow on the left) serves as reverse polarity protection.

- ◆ Fit both CAN connections (brown/white) of partial wire harness C of the central control unit with spade connectors and mount the plug housing. Polarity of the wires as shown in the adjacent illustrated.

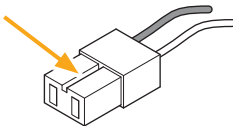

The notch (see arrow left) serves as reverse polarity protection.

(The spade connectors and the plug housing are included in "Plug set A+B+C".)

- ◆ The white plug housings of wire harnesses C and L are connected to each other. Check the polarity of the wires by comparing the colors, correct if necessary.

	<b>NOTE</b>
	<p>Partial wire harness C must be laid so that the open end (with the white plug) is located <b>inside</b> the drive's cabin or <b>inside</b> a protected room.</p> <ul style="list-style-type: none"> <li>▶ The open end of partial wire harness C does <b>not</b> meet the ADR requirements.</li> <li>▶ The open end of partial wire harness C is not suitable for outside installation (<b>no</b> IP69k).</li> </ul>

- ◆ Lay the branch with the open end of partial wire harness L to the third-party system.  
For this, determine a suitable cable feed through out of the fuse box to the access point of the third-party system, it may be necessary to disconnect components of the dashboard (see operating manual).

	<b>NOTE</b>
	<ul style="list-style-type: none"> <li>▶ During installation, ensure that the diagnostics plug of partial wire harness L is positioned for easy access.</li> </ul>

- ◆ Lay partial wire harness L and secure sufficiently with cable binders.

- ◆ Fix the branch with the diagnostics plug appropriately.

<b>i</b>	<b>NOTE</b>
	<p>Partial wire harness L may <b>only</b> be used <b>inside</b> the drive's cabin or inside a protected room.</p> <ul style="list-style-type: none"> <li>▶ Partial wire harness L does <b>not</b> meet ADR requirements.</li> <li>▶ Partial wire harness L is not suitable for outside installation (<b>no</b> IP69k)</li> </ul>

For final connection work, pay attention to the following:

<b>Option</b>	<b>Action</b>
Termination resistor of partial wire harness L not required.	◆ Short the cable accordingly.
Termination resistor of partial wire harness L not used.	<ul style="list-style-type: none"> <li>◆ Do <b>not</b> shorten cable.</li> <li>◆ Lay the excess cable in loops and secure with at least 2 cable binders.</li> </ul>
Termination resistor in the central control unit not required.	◆ Install partial wire harness E (see chapter <b>„5.9.2.3 Deactivating the CAN termination resistor in the central control unit(optional)“</b> ).

- ◆ Connect the open ends of partial wire harness L to the third-party system. Establish the connections according to the manufacturer documentation of the third-party system. Pay attention to the correct polarity. For partial wire harness L:
  - brown: CAN low
  - white: CAN high

- ◆ Connect the black plug housing of partial wire harnesses A and C to each other.
- ◆ Connect partial wire harness A to terminal 15 (ignition - red) and to terminal 31 (ground cable - black).
- ◆ Subsequently lock the fuse box again properly. Take into consideration that the original sealing of the fuse box must be ensured after completing the installation.
- ◆ Secure loosened parts of the instrument panel again.
- ◆ Under menu item "CAN Check", the Hand-Held Tool allows you to check whether the connection to the third-party system was successful.

	NOTE
	<ul style="list-style-type: none"><li>▶ If the system is connected to a third-party system, consult the supplier of the third-party system to clarify which CAN bus format is required for this application:<ul style="list-style-type: none"><li>- CPC+J1939: PGNs 65268, 65280, 65281, 65282, 65284</li><li>- J1939 Standard: PGN 65268</li></ul></li><li>▶ Settings are made via the Hand-Held Tool within "<b>Installation - New Installation</b>" or "<b>Modification - Modify Installation - Modify Parameters</b>".</li></ul>

## 5.9.2.3 Deactivating the CAN termination resistor in the central control unit(optional)

	NOTE
	<p>► If the CAN termination resistor of the central control unit (CCU) is deactivated by partial wire harness E, pay attention to the specifications of SAE J1939-15 or the permissible lengths of the CAN line and the branch lines.</p>

Partial wire harness E must be used when the CAN termination resistor in the central control unit must be deactivated (see chapter „5.9.2.2 *Connecting the CPC system to a third-party system*“).

For this, partial wire harness E must be mounted between partial wire harness C and the central control unit (CCU) (see illustration below).

Basic principle of the wiring when connecting partial wire harness E.

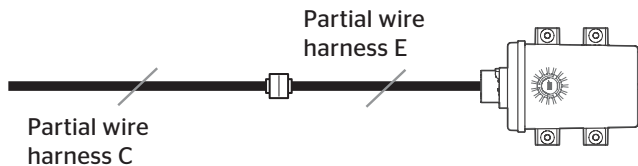

If an additional receiver is used, partial wire harness E can be mounted between partial wire harness D and the central control unit (CCU) (see illustration below) or partial wire harnesses C and D.

Basic principle of the wiring when connecting partial wire harness E and the additional receiver used.

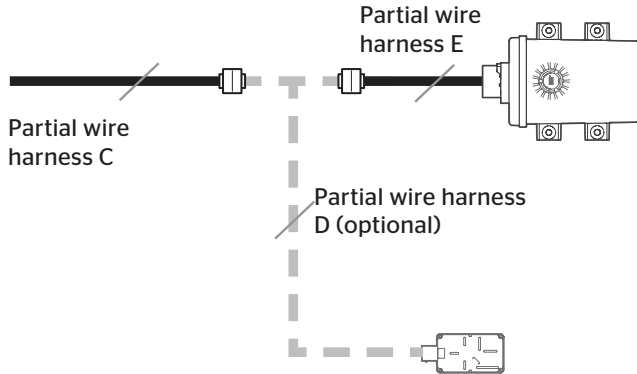

For both plug connections of partial wire harness E, the following is recommended after successful wire harness installation:

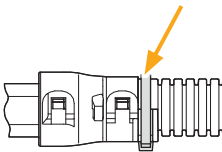

- ◆ Fix the corrugated pipe at the input for covering both plug connectors with an additional cable binder (see arrow) so that the corrugated pipe cannot detach itself from the connector cover in unfavorable conditions.



## 5.10 Installation of the central control unit and an optional additional receiver on the trailer/semi-trailer

	<b>NOTE</b>
	<p>► On complex trailers/semi-trailer (e.g. more than 3 axles), the use of an additional receiver is recommended. In this case the central control unit should be positioned as close as possible to the first/last axle, and the additional receiver as close as possible to the last/first axle (determine the position of the central control unit according to the access to the distributor box and the installation position of the pressure control indicator).</p>

	<b>ATTENTION</b>
	<p><b>Damage to the control unit!</b></p> <p>The control unit can be damaged by the proximity to high temperatures, rotating or moving parts.</p> <p>► When selecting the installation location, avoid proximity to high temperatures and to rotating or moving parts.</p>

- ◆ Install the holder of the central control unit at a suitable location in the area mid-way between the axles.

- ◆ Allow the central control unit to extend as far as possible downwards in order to ensure good reception of the tire sensor radio signals (observing safety distances, e.g. to the road). For a good reception quality, the central control unit must not be shielded by metal walls in the direct vicinity.
- ◆ For fixing the holder and aligning the control unit, see chapter „**5.4.2 Mounting**“.
- ◆ Lay branch G of wire harness F+G temporarily on the vehicle (detailed description in chapter „**5.12 Installation of the F+G wiring harness from the central control unit to the pressure control indicator, diagnostic port and distributor box**“) in order to check whether the length of branch G is sufficient to connect the central control unit to the pressure control indicator. The position of the pressure control indicator may have to be adjusted accordingly.

## 5.11 Installation and adjustment of the pressure control indicator.

### 5.11.1 Installation position of the pressure control indicator

The installation of the pressure control indicator is preferably between first and second side-marker lamp on the left-hand side of the vehicle. With long trailers, the pressure control indicator can also be installed further back due to the wiring harness length available. Install the pressure control indicator like a side-marker lamp on the vehicle.

	NOTE
	<ul style="list-style-type: none"><li>▶ The pressure control indicator must not obstruct the visibility of the side-marker lamp.</li><li>▶ Keep a free beam angle of at least 45° in front of and behind side-marker lamps.</li><li>▶ Side-marker lights must not be removed or repositioned.</li><li>▶ The pressure control indicator is not a substitute for a side-marker lamp or other lights. It does not belong to the vehicle lighting in accordance with regulation UN ECE R 48. It may only be installed on the vehicle in conjunction with the Conti-PressureCheck™ system.</li></ul>

	ATTENTION
	<p><b>Damage to the pressure control indicator!</b></p> <p>Risk of damage if the pressure control indicator is installed in the marked area for crane loading.</p> <ul style="list-style-type: none"><li>▶ Do not use the marked area on trailers suitable for crane loading.</li></ul>

**ATTENTION****Damage to the pressure control indicator!**

If the pressure control indicator is installed on vehicle with tailgates there is a risk of damage to the bracket of the pressure control indicator by the falling tailgate. The rubber arm of the pressure control indicator is flexible and may be deformed to a certain extent when tailgate is lowered. The deflection movement of the rubber arm should not, however, be hindered by unevenness and projecting parts on the tailgate. When the tailgate is raised again, the arm of the pressure control indicator should return automatically to its original orientation.

- ▶ Position the bracket of the pressure control indicator accordingly and check the deformation of the rubber arm.

## Conditions of the installation position

- For good adjustability, position the pressure control indicator approx. 30-40 mm (1.18 - 1.57 inch) from the outer edge of the vehicle. When the rubber arm is in middle position, the pressure control indicator extends approx. 20 mm (0.79 inch) beyond the edge of the vehicle.

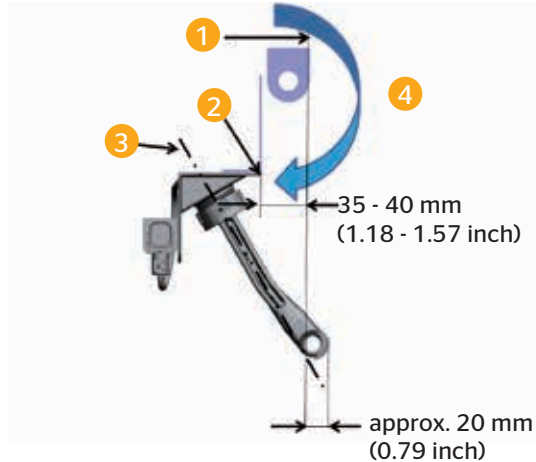

- ① Maximum vehicle width
- ② Edge of holder of pressure control indicator
- ③ Middle position of the rubber arm
- ④ Caution on vehicles with tailgate

- The pressure control indicator can be further inside, e.g., for tank vehicles.  
Ensure, however, that the visibility in the wing mirror when driving straight ahead is not obstructed.
- Install the holder of the pressure control indicator in a horizontal position.
- If the pressure control indicator cannot be installed directly on the frame of the vehicle, a corrosion-resistant adapter (e.g. of sheet aluminum) must be manufactured. The adapter should be dimensioned such that swinging of the pressure control indicator is ruled out. The form and size of the adapter can be similar to the adapter for the side-marker lights of the respective vehicle. Observe the slot dimensions on the bracket for the pressure control indicator.
- Immediately coat all bores drilled in the vehicle frame with a corrosion inhibitor.

## 5.11.2 Installation of the pressure control indicator.

If possible, install the bracket for the pressure control indicator in one of the two positions A. Position the bracket in the middle of the slot in order to allow adjustment during installation.

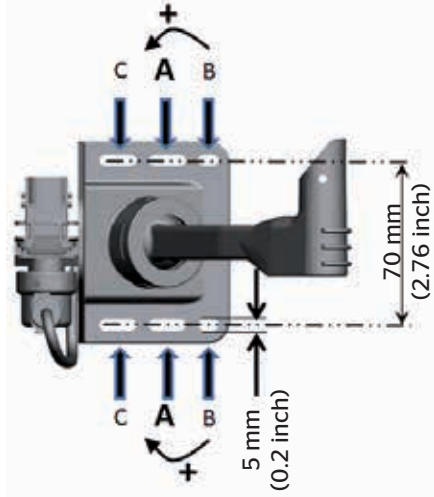

NOTE	
<b>i</b>	▶ Use at least 2 screws for the bracket.
	▶ Installation at position B only is not permitted.

- ◆ Drill 2 holes with  $\varnothing$  5.5 mm at position A in the frame or adapter with a gap of 70 mm.  
Protect the drill holes against corrosion.
- ◆ Fix the pressure control indicator with  $\varnothing$  5 mm screws.  
Screw types: self-locking with spring loading.
- ◆ Use washers with 15 mm diameter to fix the holder of the pressure control indicator.

**NOTE**

- ▶ Screws and washers are not part of the installation kit.



# Setup

## 5.11.3 Adjustment of the pressure control indicator.

The pressure control indicator has a beam angle of 5°. In this range, it has the optimum illuminance. Outside this beam angle the illuminance decreases very rapidly. The diameter of the beam at a distance of 7 m (7.66 yd) is approx. 60 cm (23.6 inch)

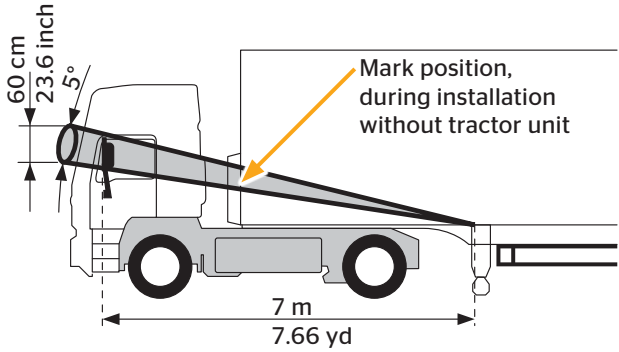

Figure: Pressure control angle with beam directed at a mirror.

### 5.11.3.1 Adjustment with tractor unit in front of the trailer

- ◆ Position the vehicle straight.
- ◆ Use the Hand-Held Tool to activate the pressure control indicator so that it lights up. To do this, connect the diagnostic cable to the Hand-Held Tool and the plug of the pressure control indicator and switch on the Hand-Held Tool.
- ◆ Loosen the lock nut on the bracket of the pressure control indicator.
- ◆ Loosen the slide ring from the rubber arm for optimum adjustment of the pressure control indicator.
- ◆ Align the pressure control indicator roughly with the wing mirror of the driver's cab.  
 Help for the installer:  
 If maximum luminosity is detected in the spherical mirror when glancing from the pressure control indicator, the pressure control indicator is properly set.
- ◆ Align the pressure control indicator so that the driver can see it perfectly in the wing mirror. Ensure that the center axis of the light beam of the pressure control indicator is in the top right-hand area of the mirror. This is checked in the following point.
- ◆ Checking the alignment:

Checking	Result
Bend rubber arm slightly upwards and towards the vehicle	Illuminance decreases slightly.
Move in the opposite direction	Illuminance remains the same.

- ◆ If necessary, readjust the alignment of the pressure control indicator.

- ◆ Tighten lock nut to 2 Nm (1.48 lb-ft) (finger-tight) so that the ball joint of the rubber arm can no longer move within the mounting

	NOTE
	<ul style="list-style-type: none"><li>▶ The material becomes more rigid at low temperatures.</li><li>▶ At temperatures below 2°C (35.6 °F) the tightening torque should not exceed 2 Nm (1.48 lb-ft) otherwise there is a risk of damage.</li><li>▶ At higher temperature, check and adjust the tightening torque accordingly.</li></ul>

- ◆ Check the visibility of the pressure control indicator during the test drive.  
If necessary, correct alignment.

### 5.11.3.2 Prealignment of the pressure control indicator on the trailer without towing vehicle

- ◆ Before uncoupling the towing vehicle, determine the position of the pressure control indicator on the trailer.
- ◆ By surveying from this position, mark the upper edge of the wing mirror on the corner of the trailer.
- ◆ When the trailer is unhitched, use this mark on the corner of the trailer for later alignment of the pressure control indicator.
- ◆ Switch on the installed pressure control indicator and align with the mark on the trailer (see section „**5.11.2 Installation of the pressure control indicator.**“).
- ◆ For checking the alignment of the pressure control indicator, the user should position himself so that his head is at the same height as the mark on the trailer and then move his head according to the instructions in the table. Alignment is correct when the luminosity during checking is as described in the table:

Movement of the head	Result
approx. 20-30 cm (7.8-11.8 inch) towards the vehicle	Illuminance decreases slightly.
approx. 20-30 cm (7.8-11.8 inch) downwards	Illuminance decreases slightly.
approx. 20-30 cm (7.8-11.8 inch) upwards	Illuminance remains the same.

# Setup

- ◆ Check position of the pressure control indicator later with tractor unit.
- ◆ Check position:

Setting	Result
Bend rubber arm slightly upwards and towards the vehicle	Illuminance decreases slightly.
Move in the opposite direction	Illuminance remains the same.





- ◆ If necessary, readjust the pressure control indicator.
- ◆ Tighten lock nut to 2 Nm (1.48 lb-ft) (finger-tight) so that the ball joint of the rubber arm can no longer move within the mounting

	NOTE
	<ul style="list-style-type: none"> <li>▶ The material becomes more rigid at low temperatures.</li> <li>▶ At temperatures below 2 °C (35.6 °F) the tightening torque should not exceed 2 Nm (1.48 lb-ft) otherwise there is a risk of damage.</li> <li>▶ At higher temperature, check and adjust the tightening torque accordingly.</li> </ul>

- ◆ Check the visibility of the pressure control indicator during the test drive.  
If necessary, correct alignment.

## 5.12 Installation of the F+G wiring harness from the central control unit to the pressure control indicator, diagnostic port and distributor box

	<table border="1" style="width: 100%; border-collapse: collapse;"> <thead> <tr style="background-color: #cccccc;"> <th data-bbox="476 295 988 359" style="text-align: center; padding: 5px;">NOTE</th> </tr> </thead> <tbody> <tr> <td data-bbox="476 359 988 627" style="padding: 5px;"> <ul style="list-style-type: none"> <li>▶ If an additional receiver is installed for the trailer/semi-trailer, connect partial wiring harness H to the additional receiver and the central control unit. Obtain installation instructions from chapters „<b>5.5 Installation of an additional receiver (optional)</b>“ and „<b>5.6 Installation of partial wiring harness D from the central control unit to the additional receiver</b>“.</li> </ul> </td> </tr> </tbody> </table>	NOTE	<ul style="list-style-type: none"> <li>▶ If an additional receiver is installed for the trailer/semi-trailer, connect partial wiring harness H to the additional receiver and the central control unit. Obtain installation instructions from chapters „<b>5.5 Installation of an additional receiver (optional)</b>“ and „<b>5.6 Installation of partial wiring harness D from the central control unit to the additional receiver</b>“.</li> </ul>
NOTE			
<ul style="list-style-type: none"> <li>▶ If an additional receiver is installed for the trailer/semi-trailer, connect partial wiring harness H to the additional receiver and the central control unit. Obtain installation instructions from chapters „<b>5.5 Installation of an additional receiver (optional)</b>“ and „<b>5.6 Installation of partial wiring harness D from the central control unit to the additional receiver</b>“.</li> </ul>			

	<table border="1" style="width: 100%; border-collapse: collapse;"> <thead> <tr style="background-color: #ff8c00;"> <th data-bbox="476 649 988 715" style="text-align: center; padding: 5px;">  <b>WARNING</b> </th> </tr> </thead> <tbody> <tr> <td data-bbox="476 715 988 1086" style="padding: 5px;"> <p><b>Risk of injury with ADR vehicles!</b></p> <p>If the CPC system is installed in a vehicle for hazardous materials (ADR) and the CPC system remains switched on although the vehicle ignition is switched off, it is possible that sparks, other ignition sources or similar could lead to a reaction with the hazardous material in the event of a fault. This can result in explosions and serious injuries.</p> <ul style="list-style-type: none"> <li>▶ Ensure that the power supply to the CPC system is switched off when the vehicle is parked.</li> </ul> </td> </tr> </tbody> </table>	 <b>WARNING</b>	<p><b>Risk of injury with ADR vehicles!</b></p> <p>If the CPC system is installed in a vehicle for hazardous materials (ADR) and the CPC system remains switched on although the vehicle ignition is switched off, it is possible that sparks, other ignition sources or similar could lead to a reaction with the hazardous material in the event of a fault. This can result in explosions and serious injuries.</p> <ul style="list-style-type: none"> <li>▶ Ensure that the power supply to the CPC system is switched off when the vehicle is parked.</li> </ul>
 <b>WARNING</b>			
<p><b>Risk of injury with ADR vehicles!</b></p> <p>If the CPC system is installed in a vehicle for hazardous materials (ADR) and the CPC system remains switched on although the vehicle ignition is switched off, it is possible that sparks, other ignition sources or similar could lead to a reaction with the hazardous material in the event of a fault. This can result in explosions and serious injuries.</p> <ul style="list-style-type: none"> <li>▶ Ensure that the power supply to the CPC system is switched off when the vehicle is parked.</li> </ul>			



## ATTENTION

### Damage to the wiring harness!

The wiring harness can be damaged by the proximity to high temperatures, rotating or moving parts.

- ▶ Avoid routing the wiring harness near sources of heat (e.g. exhaust system) or rotating or moving parts.

- ◆ Connect the 12-pin plug of wiring harness F+G to the central control unit or to the mating plug of partial wiring harness H, if used.
- ◆ Lay the wiring harness (branch G) along the existing wiring harness of the vehicle to the pressure control indicator and fasten loosely with cable straps. Connect the plug of branch G to the plug of the pressure control indicator. Wind the rest of branch G in loops and fix appropriately to the vehicle with at least 2 cable binders.
- ◆ Lay branch F from the central control unit at the existing wire harness to the distribution box or to the vehicle -power supply and secure loosely with cable binders.

- ◆ Find a suitable cable feedthrough in the distributor box and thread in the cable.
- ◆ Shorten branch F to the required length, if necessary.

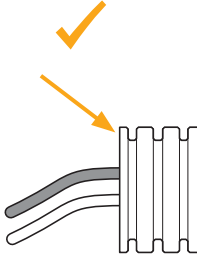

### NOTE

- ▶ Shorten the corrugated pipe on the wiring harness in "upper" areas and not "lower" areas as shown in the adjacent illustration. Otherwise there is a risk that wires routed on the inside could fray in the "lower" edge during operation.

- ◆ In the distributor box, attach the fuse supplied (fuse kit F) to the plus cable (red) using the cable shoes in the kit.
- ◆ In the distributor box, identify terminals U\_bat and GND. Pay attention to the special instructions in the vehicle operating manual.
- ◆ Connect the red cable in branch F (incl. fuse) to terminal U\_bat and the black cable to terminal GND.
- ◆ Subsequently lock the distribution box again properly. Take into consideration that the original sealing of the distribution box must be ensured after completing the installation.
- ◆ Finally secure branches F and G along the vehicle wiring harness with cable straps once again.

For the plug connection at the central control unit or to partial wire harness H, the following is recommended after installing the wire harness:

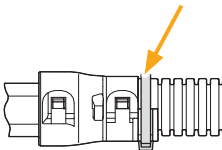

- ◆ Fix the corrugated pipe at the input for covering the plug with an additional cable binder (see arrow) so that the corrugated pipe cannot detach itself from the connector cover in unfavorable conditions.



## 5.13 CPC for a trailer connected to a third-party system

If the CPC system is connected to trailers with a third-party system (e.g., to a telematic system), contact the manufacturer.

**Continental Reifen Deutschland GmbH**

Jädekamp 30

30419 Hannover

Germany

## 5.14 Checks after installation

After completing the installation:

- ◆ Check all systems of the vehicle (e.g. brake and lighting system) for proper function.

## 6 Initialization using Hand-Held Tool

	NOTE
	<p>► Obtain all information and handling instructions on the Hand-Held Tool from the <i>"Hand-Held Tool user manual"</i>.</p>

There are 2 versions of the tire sensor (see „**3.1 Tire sensor**“):

The system is designed to function with both tire sensor generations.

The following forms of operation are possible:

- Configuration only with Generation 1 tire sensors
- Configuration only with Generation 2 tire sensors
- Mixed configuration  
(Generation 1 and Generation 2 tire sensors)

Ensure that the latest software release is installed on the vehicle components (CCU and display) to enable operation with Generation 2 tire sensors.

Notes on software installation can be found in the **user manual of the Hand-Held Tool**.

Initializing with the hand-held terminal allows the system to be suitably set for any vehicle configuration (a maximum of 32 tires spread over 8 axles can be monitored with one system).

For this, proceed as follows:

- ◆ Switch on the Hand-Held Tool.
- ◆ Select the **"Installation - New Installation"** menu item.
- ◆ Follow the instructions on the Hand-Held Tool.

# Initialization using Hand-Held Tool

	NOTE
	<ul style="list-style-type: none"><li>▶ The operator of the vehicle must ensure that the system is properly installed and commissioned. This includes setting the nominal pressures recommended, correct assignment of the tire sensors to the wheel position, etc.</li><li>▶ When setting the nominal pressure for the individual axes, pay attention to the tire manufacturers' instructions.</li></ul>

◆ For setting the CAN bus format, observe the following:

- **CPC system as independent system.**  
Select CAN bus format "**CPC+J1939**".
- **The CPC system is connected to a third-party system.**  
Check with the supplier of the third-party system which CAN BUS format is required:

CPC+J1939: PGNs 65268, 65280, 65281,  
65282, 65284

J1939 standard: PGN 65268

When the vehicle configuration has been selected and all relevant settings made, the tire sensors are taught in.

	NOTE
	<ul style="list-style-type: none"><li>▶ The first axle is shown on the left-hand side of the Hand-Held Tool display, the last axle on the right-hand side.</li></ul>

◆ Hold the Hand-Held Tool in the wheel position shown and against the side wall and follow the animation on the display.

	NOTE
	<ul style="list-style-type: none"> <li>▶ To read the tire sensor of the inner twin tires, the Hand-Held Tool can remain on the outer on the twin tires.</li> </ul>

- ◆ After reading out the last tire sensor, connect the Hand-Held Tool via the diagnostic cable as follows:
  - On the commercial vehicle at the diagnostic plug of the display or partial wire harness L
  - On the trailer to the plug to which the pressure control indicator is connected. To do this, disconnect the plug from the pressure control indicator.
- ◆ Follow the instructions on the Hand-Held Tool to configure the control unit.
- ◆ After successful configuration, the control unit must be switched off for at least 30 seconds. To do this, switch off the ignition or turn off the battery main switch if the control unit on the trailer has been connected to a permanent power supply. Subsequently continue with chapter „7 Test drive for system checking“.

	NOTE
	<ul style="list-style-type: none"> <li>▶ If ATL (Automatic Trailer Loading) was selected, only one nominal pressure can be set for all the tires on the trailer.</li> </ul>

**During later operation:**

	NOTE
	<ul style="list-style-type: none"> <li>▶ After replacing or changing the position of one or more tire sensors, the telegram counter in the display must be reset., for this, see chapter „1.2 Evaluation of the reception quality via display“.</li> </ul>

## 7 Test drive for system checking

### 7.1 Test drive for system checking on the commercial vehicle

	<b>NOTE</b>
	<ul style="list-style-type: none"><li>▶ Obtain all information and handling instructions for the test drive from the <b><i>Hand-Held Tool user manual</i></b>.</li><li>▶ If "J1939-Standard" option was selected for the CAN bus format, a test drive is not possible.</li></ul>



To test the whole system, carry out a test drive as follows:

- ◆ Connect the Hand-Held Tool with the display and select the menu item "**Installation - Test-drive**".
- ◆ Start the test drive.

	<b>NOTE</b>
	<ul style="list-style-type: none"><li>▶ The test drive function can be canceled at any time. To do this, press the ESC button (<b>ESC</b>) for at least 3 seconds.</li><li>▶ At speeds greater than 30 km/h (19 mph), the test drive is normally completed after 5 minutes.</li></ul>

After the start of the menu, the display on the Hand-Held Tool changes to the bird's eye perspective, the left-hand side shows the first axle of the vehicle.

The transmission power of the tire sensors (RSSI) or the number of telegrams received is shown in the tire symbols.

	<b>NOTE</b>
	▶ Change between both displays RSSI and number of telegrams using the arrow keys  .

The test drive is completed when a prompt for saving the protocol file appears on the screen.

Pressing the return button  saves the protocol file.

The result of the test drive is subsequently displayed:

- If the test drive was successful, the system is suitable for operation on the tested vehicle.
- If the test drive was not successful, corrections to the system installation are necessary (e.g. position and alignment of the CCU).

# Test drive for system checking

## 7.2 Test drive for checking the system on the semi-trailer

	NOTE
	▶ Obtain all information and handling instructions for the test drive from the <i>Hand-Held tool user manual</i> ".

Preparing for the test drive:

- ◆ Disconnect the plug of wiring harness F+G (branch G) from the pressure control indicator.
- ◆ Connect the Hand-Held Tool to branch G using the diagnostics cable and select the menu item "**Installation - Test-drive**".

When the operation has been successfully completed:

- ◆ Disconnect the Hand-Held Tool.
- ◆ Connect branch G to the pressure control indicator.
- ◆ Carry out test drive without the Hand-Held Tool.

	NOTE
	▶ At speeds greater than 30 km/h (19 mph), the test drive is normally completed after 5 minutes.

The test drive is completed when the pressure control indicator lights up for 60 seconds.

- ◆ Reconnect the Hand-Held Tool with branch G and select the menu item "**Installation - Test-drive**" again.

To complete the system check:

- ◆ Switch off the Hand-Held Tool and disconnect from branch G.
- ◆ Connect branch G to the pressure control indicator.

### 7.3 Preparation for repeating a test drive

If a test drive has to be repeated, e.g., after repositioning of the central control unit, all tire sensors must be in the so-called parking mode.

The tire sensors reset themselves to the parking mode automatically, when the vehicle was not moved for **at least 20 minutes**.

Repeating a test drive:

- ◆ The vehicle must have been standing for **at least 20 minutes**.
- ◆ Carry out the test drive as described in chapter „**7.1 Test drive for system checking on the commercial vehicle**“ or chapter „**7.2 Test drive for checking the system on the semi-trailer**“.



## 8 Modification of the system configuration

If changes are made later to the system installation, the configuration of the central control unit (CCU) has to be modified with the Hand-Held Tool.

### 8.1 Single Wheel Exchange (SWE)

The "Automatic Single Wheel Exchange" (SWE) enables easy exchange of a single tire sensor.

	<b>NOTE</b>
	<ul style="list-style-type: none"><li>▶ If the ATL (Automatic Trailer Loading) function is activated, the then automatic Single Wheel Exchange (SWE) is deactivated.</li><li>▶ If a lifting axle is raised, the automatic Single Wheel Exchange (SWE) does not function. The new tire sensor can only be detected when all lift axles have been lowered while driving. It is thereby irrelevant at which position the wheel was changed.</li></ul>

If a single tire with tire sensor is replaced during operation, the system detects this automatically. Reconfiguring with the mobile reading device is not necessary.

- The new tire sensor is usually detected automatically during the first journey after replacing the tire.

- This procedure is completed after approx. 10 minutes of driving.  
Prerequisite is a speed of min. 30 kmh (19 mph) during the duration of driving.
- No pressure value is visible in the corresponding tire symbol during this learning procedure.



## NOTE

- ▶ If the detection fails during the first drive, the message "NO SIGNAL" appears on the display for this tire position and the pressure control indicator flashes slowly.
- ▶ To restart wheel exchange detection, the vehicle **must** have been **standing still** for **20 minutes**.  
The system restarts the automatic Single Wheel Exchange (SWE) each time until the new wheel has been detected.

## 8.2 Manual adaptations with the Hand-Held Tool

Reconfiguration of the system is necessary and possible in the following cases:

- Changing the vehicle name
- Changing the CAN settings used
- Switching the trailer monitoring (ATL and SO) on/off
- Switching the additional receiver on/off
- Changing the nominal pressure for an axle
- Changing the status of an axle (lift axle yes/no)
- Changing the position of the tire sensors
- Replacement of at least 2 tire sensors (new tire sensors)

To do this, call up the following menus on the Hand-Held Tool and follow the instructions on the Hand-Held Tool:

- **"Modification - Modify Installation - Modify Parameters"**
- **"Modification - Modify Installation - Modify Sensor IDs"**

If the modifications exceed the scope described above, re-initialization is necessary as described in chapter „**6 Initialization using Hand-Held Tool**“.

## 8.3 Deactivate/activate ContiPressureCheck system

If the system exhibits a malfunction that could disturb the driver and cannot be quickly remedied, it is possible to temporarily deactivate the system.

For this, proceed as follows:

- ◆ Connect the Hand-Held Tool to the system with the diagnosis cable.
- ◆ Execute the menu item "**Modification - Deactivate CPC**".

When the system has been successfully deactivated, this is indicated at system level as follows:

- Commercial vehicle: Display message "SYSTEM NOT ACTIVE"
- Trailer: Pressure control display without function (nothing lights up for 15 seconds when the "ignition on".)

To reactivate the system:

- ◆ Connect the Hand-Held Tool to the system with the diagnosis cable.
- ◆ Execute the menu item "**Modification - Deactivate CPC**".

## 9 Documentation of system installation

After successful installation, we recommend that the vehicle configuration is transmitted to a PC and printed out for documentation purposes.

- An Excel file is available at [www.contipressurecheck.de](http://www.contipressurecheck.de) that converts the profile files to a printable format.

All tire IDs, the vehicle configuration, components installed and the settings are listed in this document.

If a test drive was carried out, there is an additional protocol file. It contains the result of the test drive, the RSSI values as well as the number of telegrams received. The file can also be transmitted to the PC and printed.

	<b>NOTE</b>
	► Obtain further information on the protocol files from the " <i>Hand-Held tool user manual</i> ".

## 10 Information on the system

### 10.1 General

- ContiPressureCheck™ supports monitoring of the tire condition, including the tire pressure. The responsibility for the correct pressure lies with the driver.
- Increase the tire pressure only when the tire temperature corresponds to the ambient temperature.

### 10.2 Check the CAN Bus

During operation of the system, carry out the following measures:

- Clean the light surface of the pressure control indicator at regular intervals.
- The driver must ensure that the pressure control indicator can be seen in the rear-view mirror. For this, the pressure control indicator lights up for 15 seconds after starting the vehicle each time.
- Keep the central control unit and the additional receiver free of soiling such as snow or slush in order not to impair the reception.

## 11 Diagnosis

It is possible to use the Hand-Held Tool to read out error code (DTC = **D**iagnostics **T**rouble **C**ode).

	<b>NOTE</b>
	► Obtain further information on the error codes (DTC) from the " <i>Hand-Held Tool user manual</i> ".

This chapter deals with the diagnostic instructions and diagnostic possibilities of the display.

## 11.1 Error messages and handling instructions

Status information	Error code	Possible cause of error	Handling instructions
SYSTEM ERROR	1001	Power to the CCU not sufficient.	Contact after-sales service (see section „ <b>1.9 Customer service</b> “).
		CAN communication does not function.	Contact after-sales service (see section „ <b>1.9 Customer service</b> “).
SYSTEM ERROR	1002	CCU has reduced CAN (not all CAN messages are available). <b>Possible reason:</b> CCU was switched on 2x for at least 72 minutes each time without receiving tire sensors.	The tire sensors with which the system configuration was carried out are not yet installed on the vehicle.  When the wheels with the corresponding tire sensors are installed, the error message disappears automatically.  If the error message continues to be displayed despite functioning tire sensors, carry out " <b>New Installation</b> " or " <b>Modify Sensor IDs</b> ".  If the error continues to occur, replace the CCU.
SYSTEM ERROR	1003	Required CAN message not available.	Contact after-sales service (see section „ <b>1.9 Customer service</b> “).

Status information	Error code	Possible cause of error	Handling instructions
SYSTEM ERROR	1004	Microcontroller or internal memory of the CCU defective.	Replace CCU.
SYSTEM ERROR	1005	Tire sensors not activated.	Activate tire sensors. Carry out test drive. If the error continues, carry out <b>"New Installation"</b> or <b>"Modify Sensor IDs"</b> .
		Tire sensors not installed in the tire.	Check whether tire sensors are installed in the tires. Make sure that the tire sensors are in the tires and subsequently carry out <b>"New Installation"</b> or <b>"Modify Sensor IDs"</b> .
		None of the tire sensors installed match the saved system configuration.	Carry out <b>"New Installation"</b> or <b>"Modify Sensor IDs"</b> .
DISPLAY ERROR	1006	Microcontroller or internal memory of the display defective.	Replace display.
SYSTEM ERROR	1008 (J1939)	"1939 standard" was selected as CAN bus format during the system configuration.	Under <b>"Modify parameters"</b> , change the CAN bus format to "CPC+J1939".



# Diagnosis

Status information	Error code	Possible cause of error	Handling instructions
SYSTEM ERROR	1009	CPC without additional receiver. CPC system incorrectly configured.	Perform " <b>Modify parameters</b> " and remove the additional receiver from the CPC configuration.
		CPC with additional receiver. Power supply interruption or short circuit in additional receiver or partial wiring harness D.	Contact after-sales service (see section „ <b>1.9 Customer service</b> “).
SYSTEM ERROR	1010	Vehicle data were not correctly stored in the display.	Carry out " <b>New Installation</b> ". Ensure that the latest software release is installed on the Hand-Held Tool.
SYSTEM NOT ACTIVE		CPC is deactivated.	Activate the system using the Hand-Held Tool (HHT).
SYSTEM NOT CONFIGURED		System is not yet configured.	Carry out " <b>New Installation</b> ".

## 11.2 Evaluation of the reception quality via display

### 11.2.1 Call the diagnostics screen

Press and hold down the **SET** button and press the button. The following appears in the display:

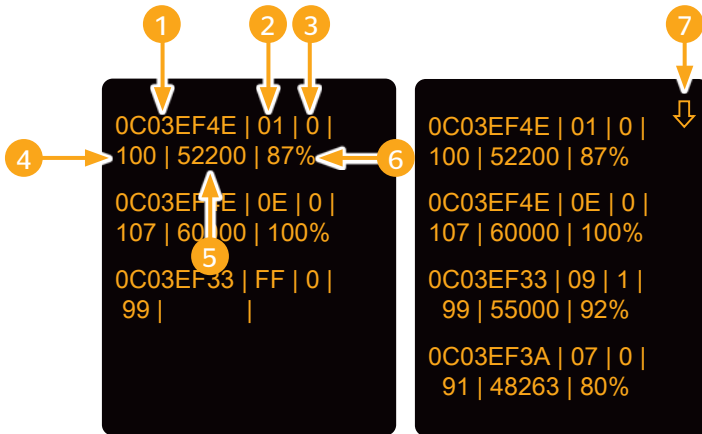

- 1 Tire sensor ID
- 2 Wheel position  
(see chapter „11.2.2 Example of the wheel positions“)
- 3 Battery charge:  
0 = OK  
1 = replace tire sensor
- 4 Number of telegrams since last ignition start
- 5 Number of telegrams since last reset of the display
- 6 Transmission power as percentage compared to the strongest signal from a tire sensor
- 7 A visible arrow indicates that you can scroll to further diagnostic pages which contain data on further tire sensors installed

## Reset telegram counter:

	NOTE
	▶ After replacing or changing the position of one or more tire sensors, the telegram counter in the display must be reset.

Press and hold the **OK** button and press the  button to reset the telegram counter.

## 11.2.2 Example of the wheel positions

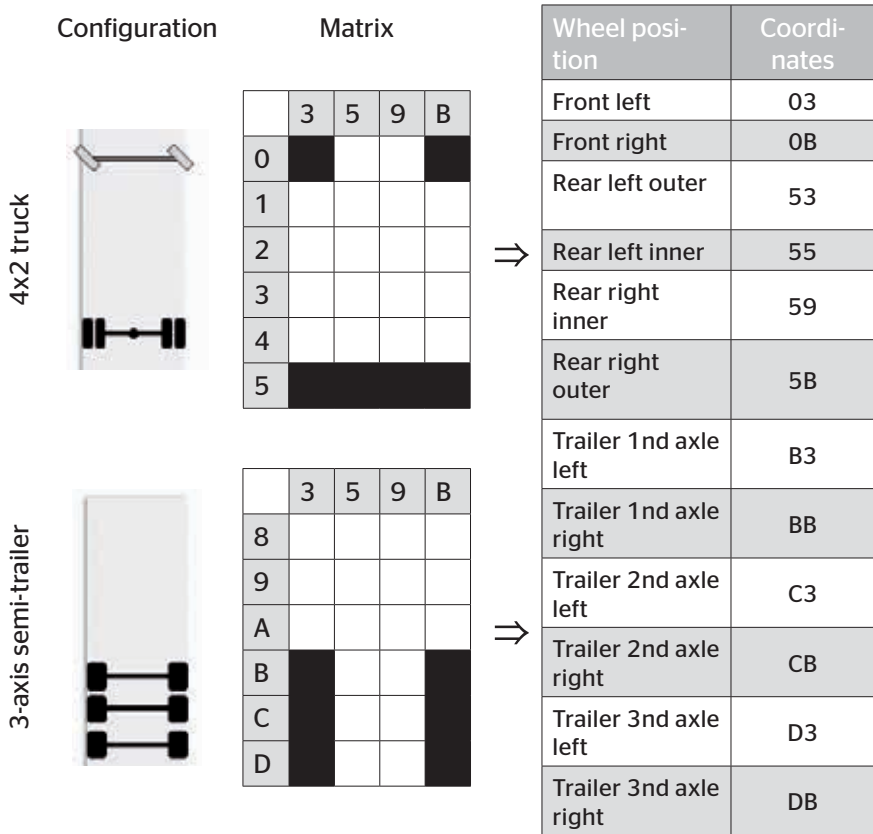

Axle numbers 0 to 5 are used for the drawing vehicle, numbers 8 to D for the drawn vehicle.

## 11.3 Display device information:

Press and hold the **SET** button and press the **OK** button to display the software and hardware version and the production date of the display:

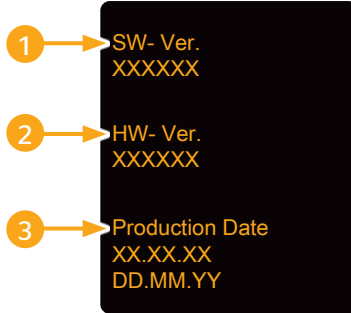

- 1 Software version
- 2 Hardware version
- 3 Productions date of the display

**Return to pressure/temperature display:**

- ◆ Press the **SET** button.

## 12 Dismantling and Disposal

### 12.1 Disassembling

	<b>⚠ CAUTION</b>
	<p><b>Danger of short-circuit</b></p> <p>Danger of short-circuits when working on the vehicle electrical system.</p> <ul style="list-style-type: none"> <li>▶ Observe the vehicle manufacturer's safety instructions.</li> <li>▶ Switch off all electrical consumers before disconnecting the battery terminals.</li> <li>▶ Disconnect the minus terminal <b>before</b> the plus terminal.</li> </ul>

The system may only be dismantled by appropriately qualified staff in observance of the local safety regulations.

- ◆ Disconnect all plugs of the wiring harnesses.
- ◆ Remove the cable straps.
- ◆ Remove the wiring harnesses.

	<b>NOTE</b>
	<ul style="list-style-type: none"> <li>▶ If the CPC system is connected to a third-party system (e.g., a telematic system or a dashboard), the CPC system connection must be removed so that the third-party system can subsequently work alone without error.</li> </ul>

## Central control unit:

- ◆ Dismantle the central control unit. For this, loosen the fixing screws on the holder and remove the central control unit.
- ◆ Remove the central control unit from the holder.

## Additional receiver

- ◆ Dismantle the additional receiver (optional), loosen the fixing screws for this and remove the additional receiver from the holder.
- ◆ Remove the additional receiver from the holder.

## Pressure control indicator:

- ◆ Dismantle the pressure control indicator. For this, loosen the fixing screws and remove the pressure control indicator.

## Display:

- ◆ Remove the display from the display bracket.
- ◆ Remove the holder from the windscreen or the dashboard.

## Complete system:

- ◆ Dispose of all system components as described in chapter „12.2 Disposal“.

	<b>NOTE</b>
	▶ If unprotected bores are left in the vehicle frame after removal of the system, these must be sealed with zinc spray.

## 12.2 Disposal

Continental is committed to the protection of the environment. After reaching the end of their service life, the individual parts/components must be disposed of in accordance with all current local, regional and national laws and regulations.

- ◆ Sort metals and plastics carefully for recycling or scrapping.
- ◆ Dispose of all other components such as cleaning agents or electrical components (such central control unit, additional receiver) according to legal regulations.
- ◆ A return to an authorized Continental sales partner or the return to the central collection point (address, see section „**12.2.4 System collection point**“) is necessary for the tire sensor and Hand-Held Tool.

### 12.2.1 Tire sensor

The tire sensor container remains in the tire and is disposed of with the tire.

	<b>NOTE</b>
	<p>► Before disposing of a tire, the tire sensor must be taken out. If the tire sensor is to continue to be used, pay attention to the service life and operating time of the tire sensor as described in chapter „<b>4.4 Tire sensor</b>“.</p>

The tire sensor contains a lithium battery that is cast into the housing and cannot be replaced.

After reaching the end of its service life, the tire sensor must be disposed of in accordance with all current local, regional and national laws and regulations. For this, a return to an authorized Continental sales partner or the return to the central collection point (address, see section „**12.2.4 System collection point**“) is necessary.



# Dismantling and Disposal

---

## 12.2.2 Hand-Held Tool

The tire Hand-Held Tool contains a lithium battery that is cast into the housing and cannot be replaced. After reaching the end of its service life, the tool must be disposed of in accordance with all current local, regional and national laws and regulations. The terminal can be taken to collection points for electrical/electronic components or to the system sales partner. Or it can be sent to the system collection point (address, see section „**12.2.4 System collection point**“).

## 12.2.3 Electrical/electronic components



All other electrical/electronic components except tire sensor and Hand-Held Tool must be disposed of in accordance with EC Directive 2012/96/EC-WEEE (Waste Electrical and Electronic Equipment). Should you have any questions, please contact your communal authority responsible for waste disposal.

## 12.2.4 System collection point

**Address:**

Continental Trading GmbH  
"Abteilung Entsorgung"  
VDO-Straße 1  
Gebäude B14  
64832 Babenhausen  
Germany

## 13 Declaration of Conformity

The CPC system meets the basic requirements and relevant regulations of the European Union (EU) and the USA as well as other countries listed at [www.contipressurecheck.com](http://www.contipressurecheck.com).

The complete original declaration of conformity is in the package leaflet:

***EC-Declaration of Conformity***

***Déclaration CE de Conformité***

***EC declaration of conformity***

or at [www.contipressurecheck.com/downloads](http://www.contipressurecheck.com/downloads).

## 14 Further documents

The individual documents are included with the system documentation and/or are available at [www.contipressurecheck.com/downloads](http://www.contipressurecheck.com/downloads).

### 14.1 Radio permit

A radio permit was issued for the CPC system in the following countries.

See list of countries package leaflet:

***Homologation Certificate Vehicle Components***

or

[www.contipressurecheck.com/system/homologation](http://www.contipressurecheck.com/system/homologation)

### 14.2 General Operating Permit

A general operating permit (Allgemeine Betriebserlaubnis - ABE) from the Kraftfahrt-Bundesamt (KBA) (Federal Motor Vehicle Transport Authority) was issued for the CPC system.

See package leaflet:

***GENERAL OPERATING PERMIT (GOP)***

***General Operating Permit (ABE)***

### 14.3 ADR

The CPC system is principally designed for hazardous material (ADR) vehicles.

A declaration of conformity according to ADR is available for the system and includes the approved hazardous goods classes, see package leaflet:

***ADR Konformitätserklärung (System)***

***ADR Declaration of Conformity (System)***

## 15 Index

### A

Abbreviations.....	8
Add. Receiver .....	27
ADR.....	107

### C

Central control unit.....	26
Connection of the system to a third-party system.....	54
Copyright protection.....	10
CPC as independent system .....	51
Customer service.....	10

### D

Deactivate/activate the system.....	92
Declaration of Conformity.....	106
Description of functions .....	23
Diagnosis .....	94
Disassembling .....	102
Display.....	28
Disposal .....	104
Documentation of system installation.....	93

### E

Error messages and handling instructions.....	95
Explanation of symbols.....	7

### F

Further documents .....	106
-------------------------	-----

### G

General Operating Permit.....	106
-------------------------------	-----

### H

Hand-Held tool .....	33
Holder.....	29

### I

Information on the system .....	94
Initialization using hand-held tool .....	82
Intended use .....	12

### L

Liability disclaimer .....	7
----------------------------	---

### M

Manufacturer's address .....	10
Modification of the system configuration .....	89

### P

Pressure control indicator .....	31
----------------------------------	----

### R

Radio permit.....	106
Requirements on staff.....	16

# Index

---

## S

Safety Notes	
Fundamental safety instructions .....	13
Particular hazards .....	14
Personal protective equipment	17
Scope of supply .....	35
Setup .....	35
Checks after installation.....	81
Installation and adjustment of the pressure control indicator...	67
Installation of an additional receiver .....	39
Installation of partial wiring harness C from the central control unit to the fuse box .....	45
Installation of partial wiring harness D from the central control unit to the additional receiver .....	43
Installation of partial wiring harness E .....	63
Installation of the central control unit .....	36
Installation of the F+G wiring harness from central control unit to the pressure control indicator .....	78
Installation of the tire sensor .....	35
Mounting the display .....	46
Single Wheel Exchange (SWE) .....	89
Spare parts.....	34
System collection point.....	105

## T

Technical data.....	18
Additional receiver (optional)....	20
Central control unit.....	20
Display .....	21
Hand-Held tool.....	22
Pressure control indicator .....	22
Tire sensor .....	18
Test drive for system checking.....	85
Tire sensor.....	25

## W

Warnings .....	9
Warranty terms .....	10





**Continental Reifen Deutschland GmbH**

Vahrenwalder Straße 9

30165 Hanover

Germany

[www.contipressurecheck.com](http://www.contipressurecheck.com)

[www.continental-truck-tires.com](http://www.continental-truck-tires.com)

[www.continental-corporation.com](http://www.continental-corporation.com)

**Continental**   
The Future in Motion

CPC\_IM\_1long\_GB/USA\_V4\_012022 A2C81582400 - 17340270000